



Deep Computer Vision

Alexander Amini

MIT Introduction to Deep Learning

January 10, 2023

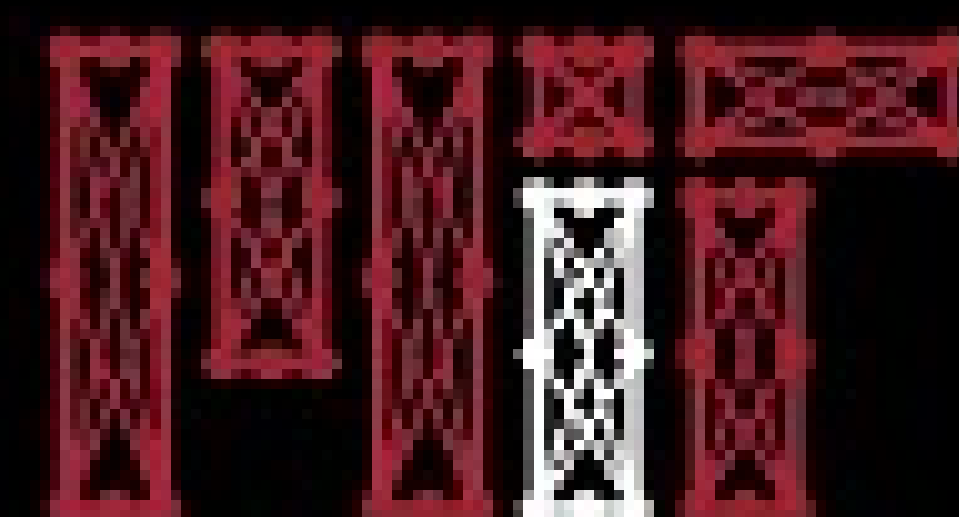

MIT Introduction to Deep Learning

introtodeeplearning.com [@MITDeepLearning](https://twitter.com/MITDeepLearning)





**“To know what is
where by looking.”**

To discover from images what is present in the world, where things are, what actions are taking place, to predict and anticipate events in the world

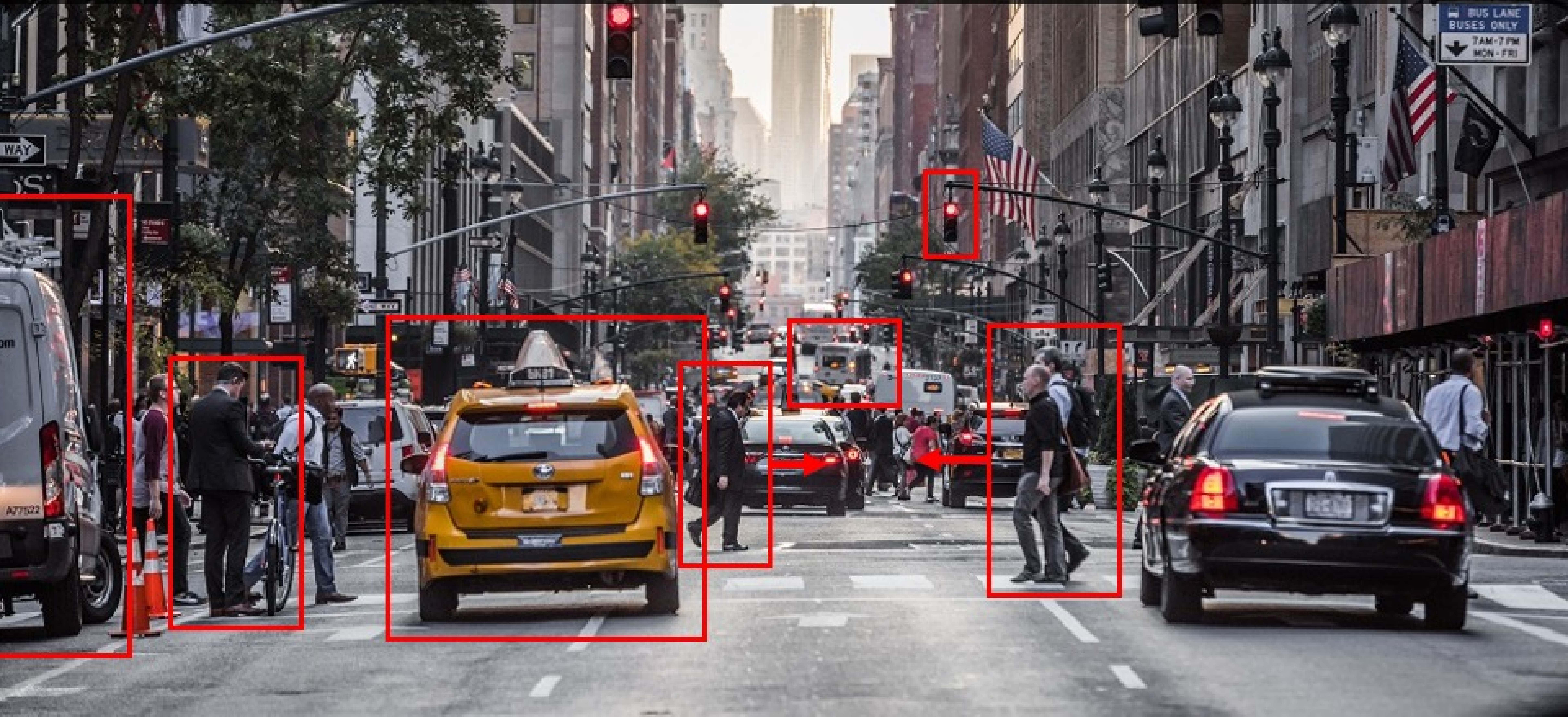

The rise and impact of computer vision

Robotics



Accessibility



Biology & Medicine

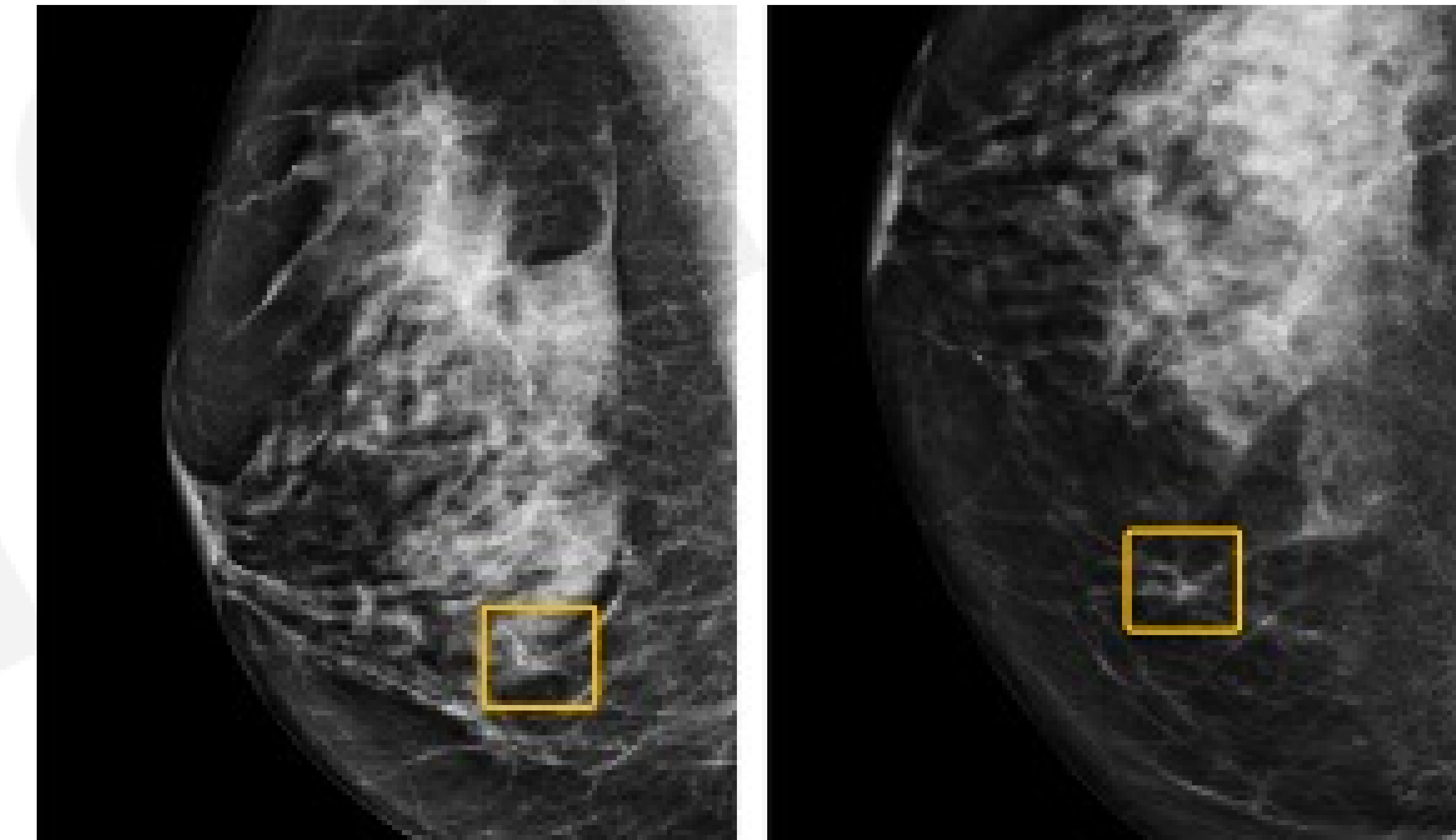

Autonomous driving



Mobile computing

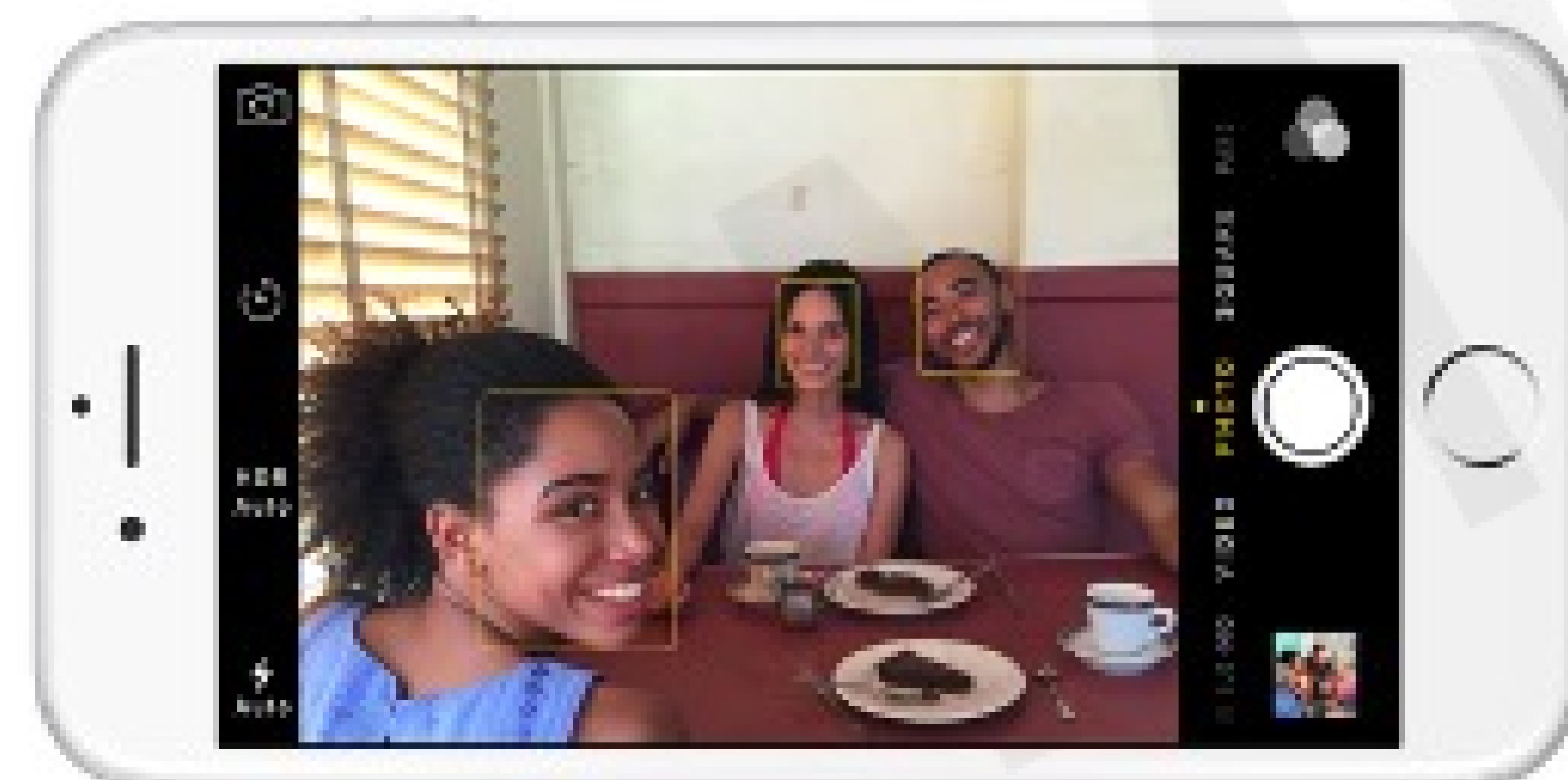

Impact: Facial Detection & Recognition

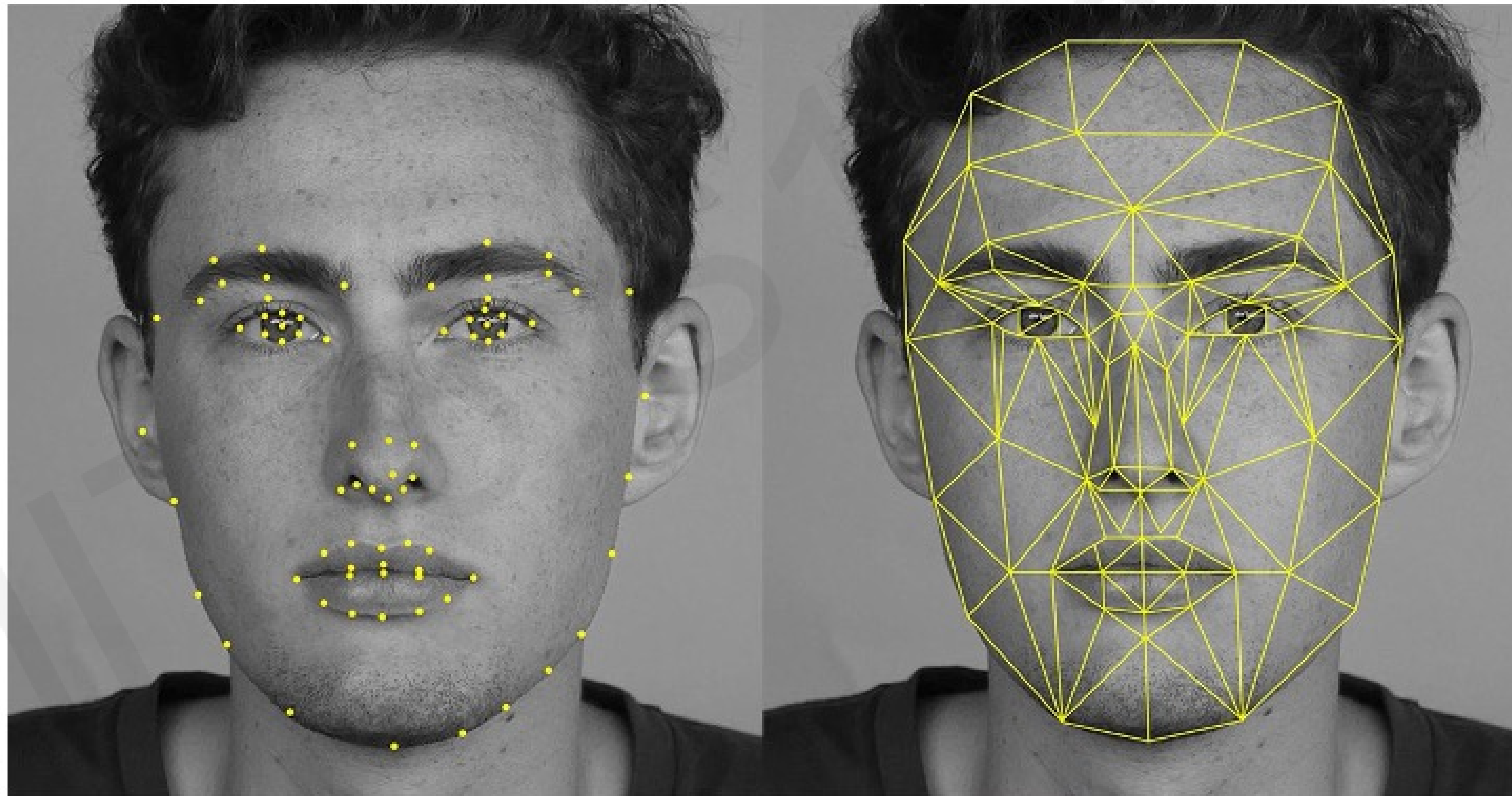
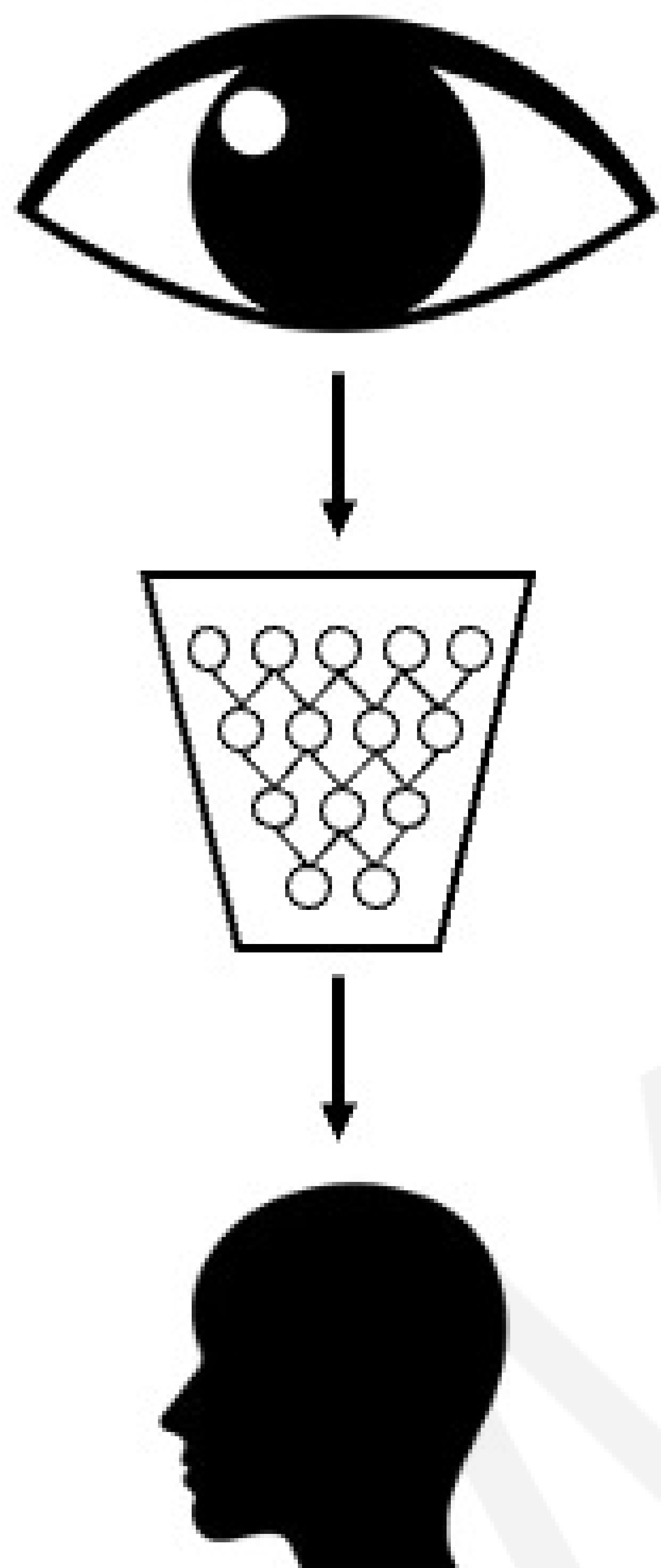

Impact: Self-Driving Cars

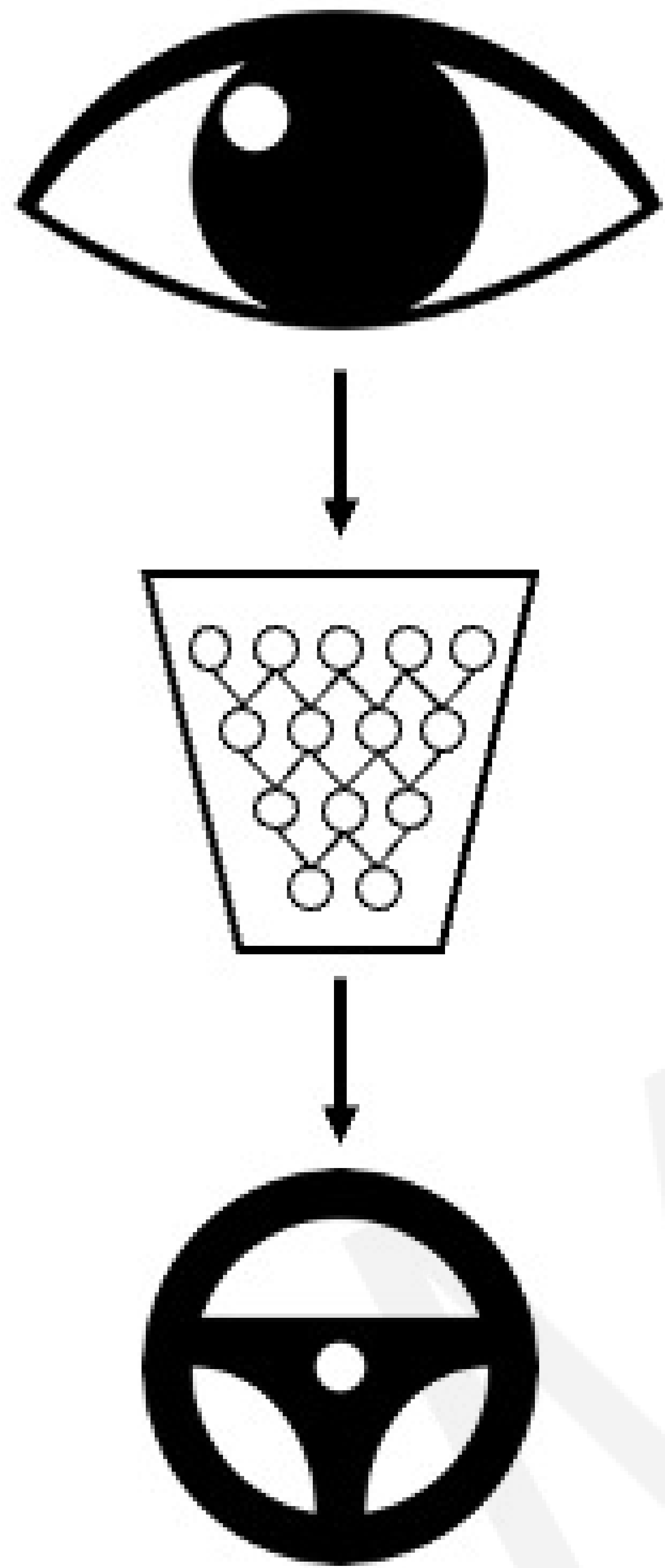

Impact: Medicine, Biology, Healthcare

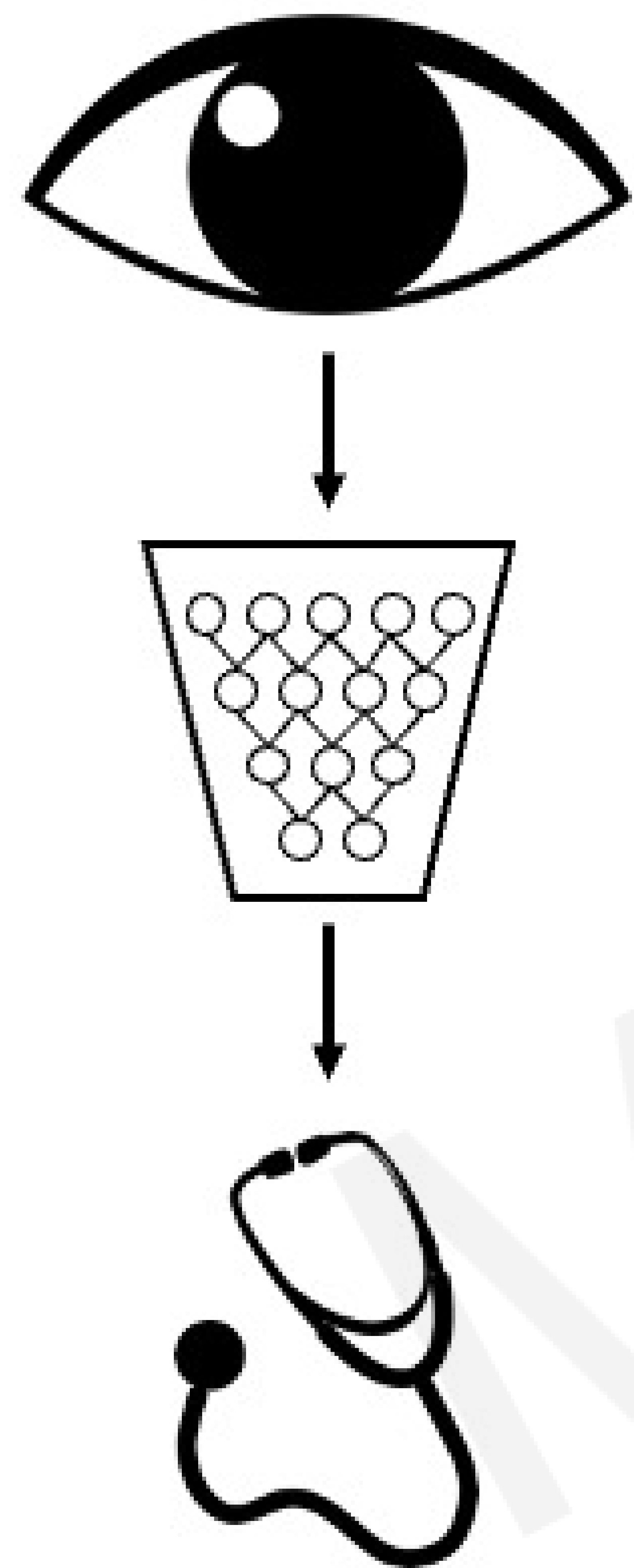

Breast cancer

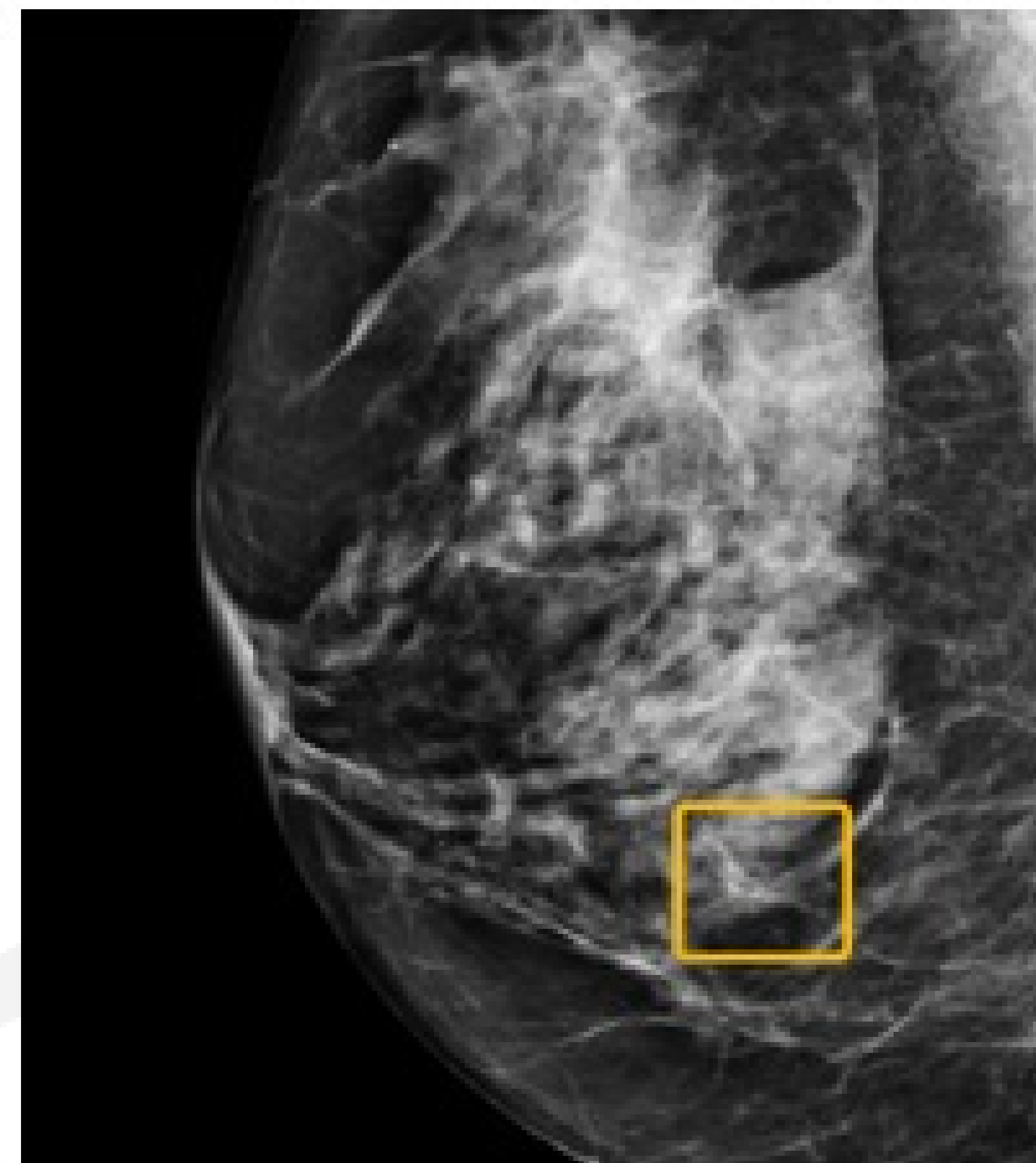

COVID-19



Skin cancer

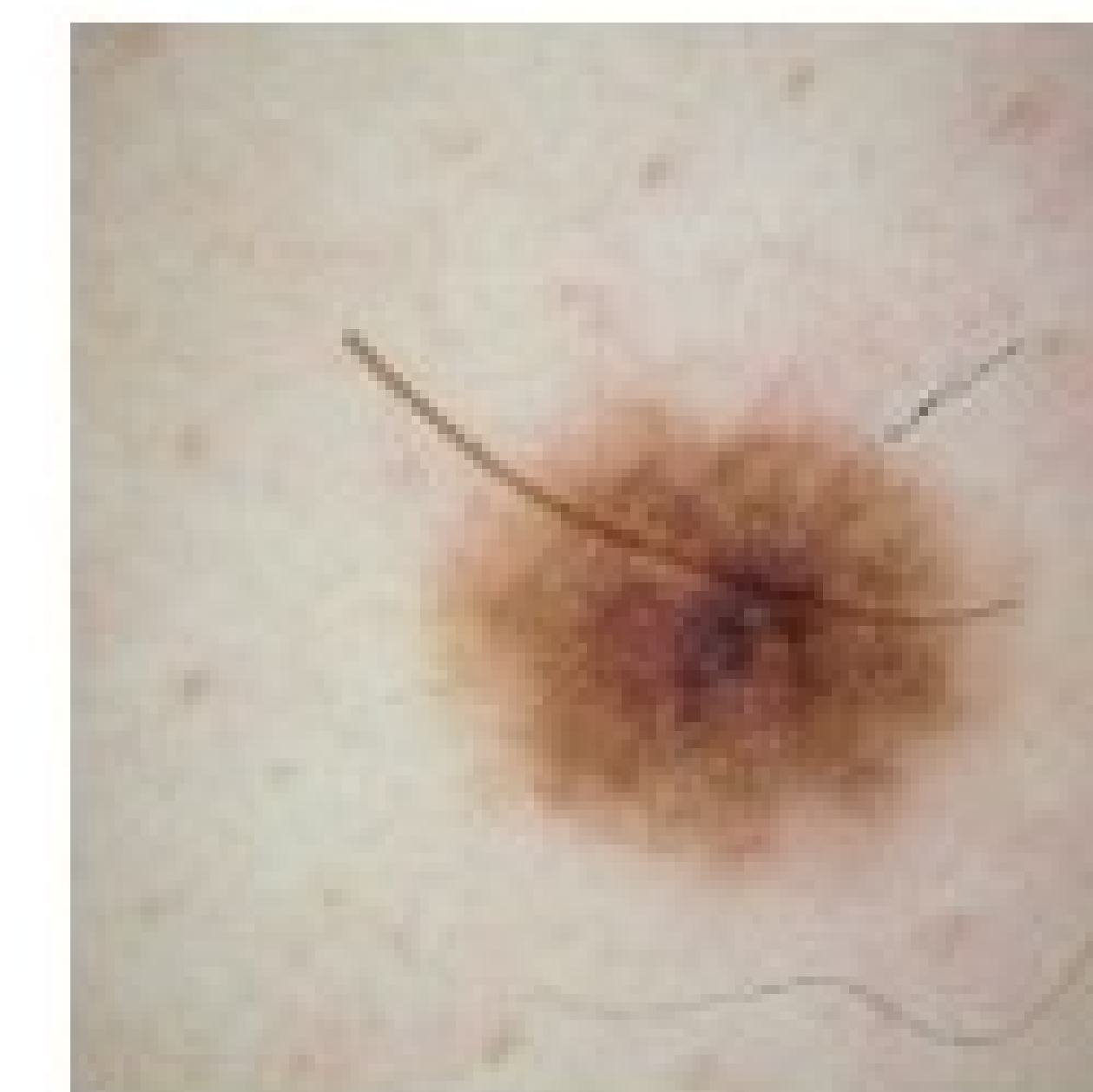

Impact: Accessibility



What Computers “See”

Images are Numbers

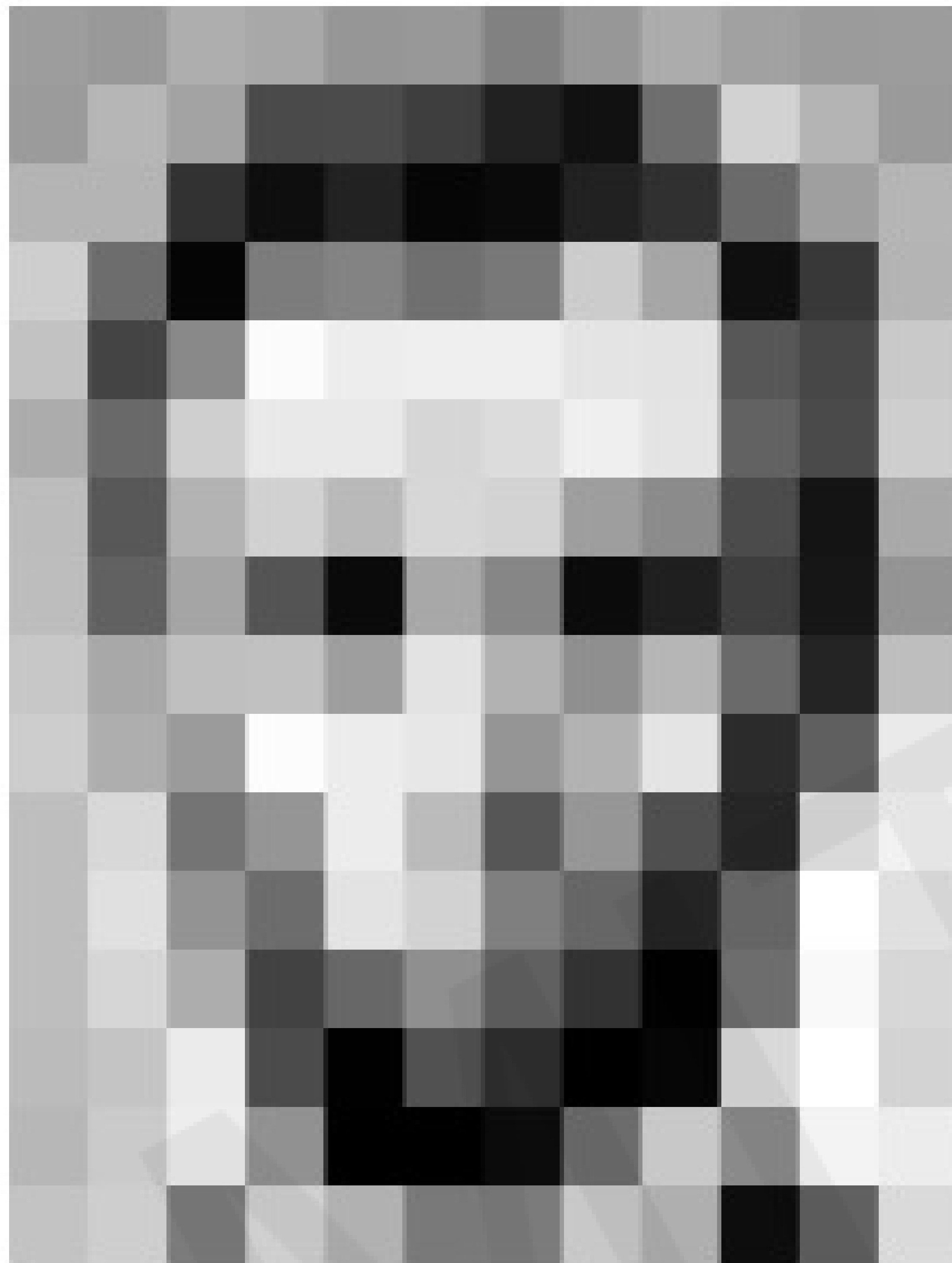

Images are Numbers

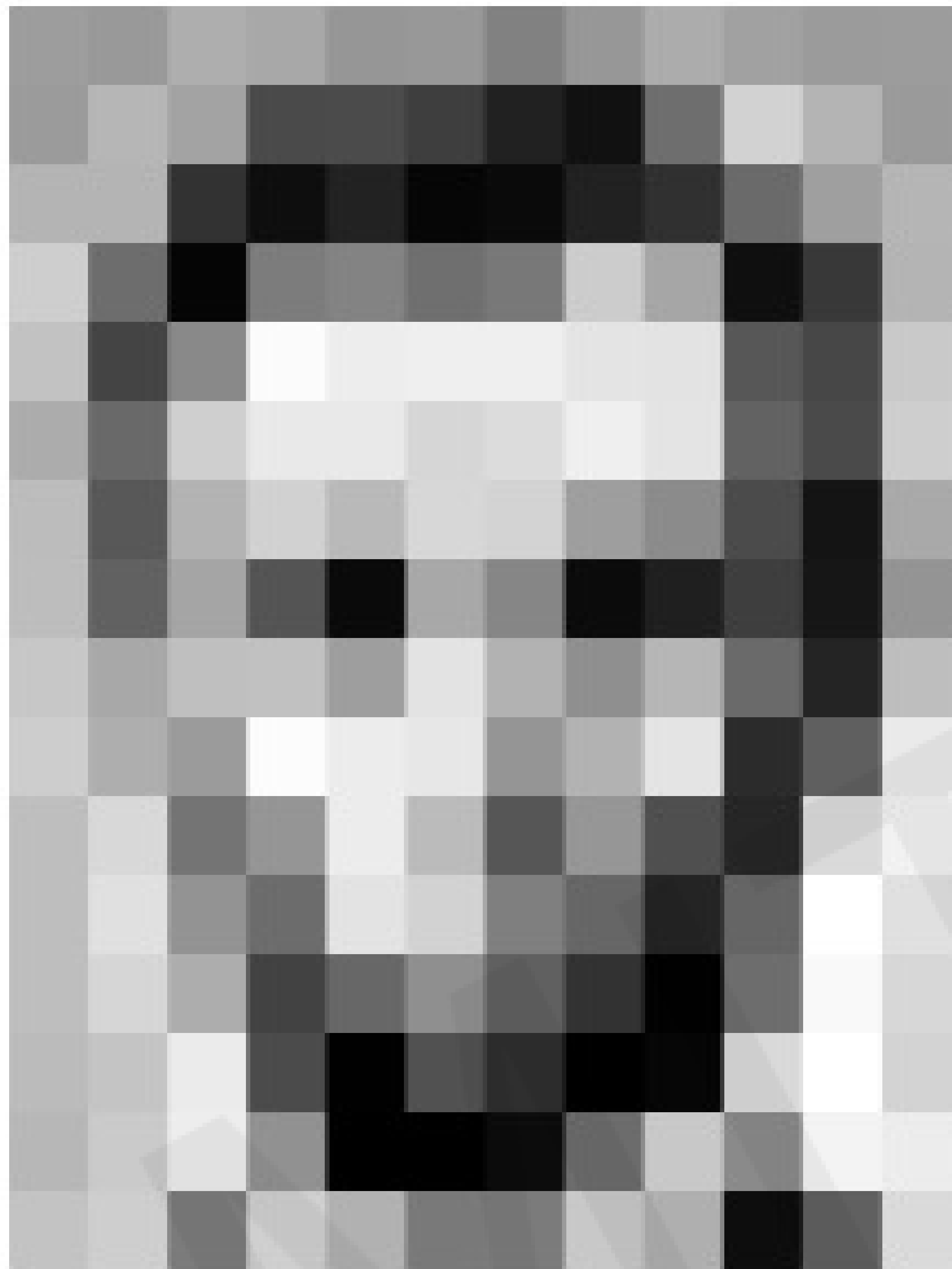

157	153	174	168	150	152	129	151	172	161	155	156
155	182	163	74	75	62	83	17	110	210	180	154
180	180	50	14	94	6	10	93	48	105	159	181
206	100	5	124	131	111	120	204	165	15	56	180
194	68	137	251	257	239	239	228	227	87	71	201
172	105	207	233	233	214	220	239	228	98	74	205
188	83	179	209	185	215	211	158	139	75	20	169
189	97	155	84	10	168	134	11	31	62	22	148
199	168	191	193	158	227	178	143	182	105	35	190
205	174	155	252	236	231	149	178	228	43	95	234
190	216	116	149	236	187	85	150	79	38	218	241
190	224	147	108	227	210	127	102	35	101	255	224
190	214	173	55	103	143	95	50	2	109	249	215
187	196	235	75	1	81	47	0	6	217	255	211
183	202	237	145	0	0	12	108	200	138	243	235
195	206	123	207	177	121	123	200	175	13	96	218

Images are Numbers

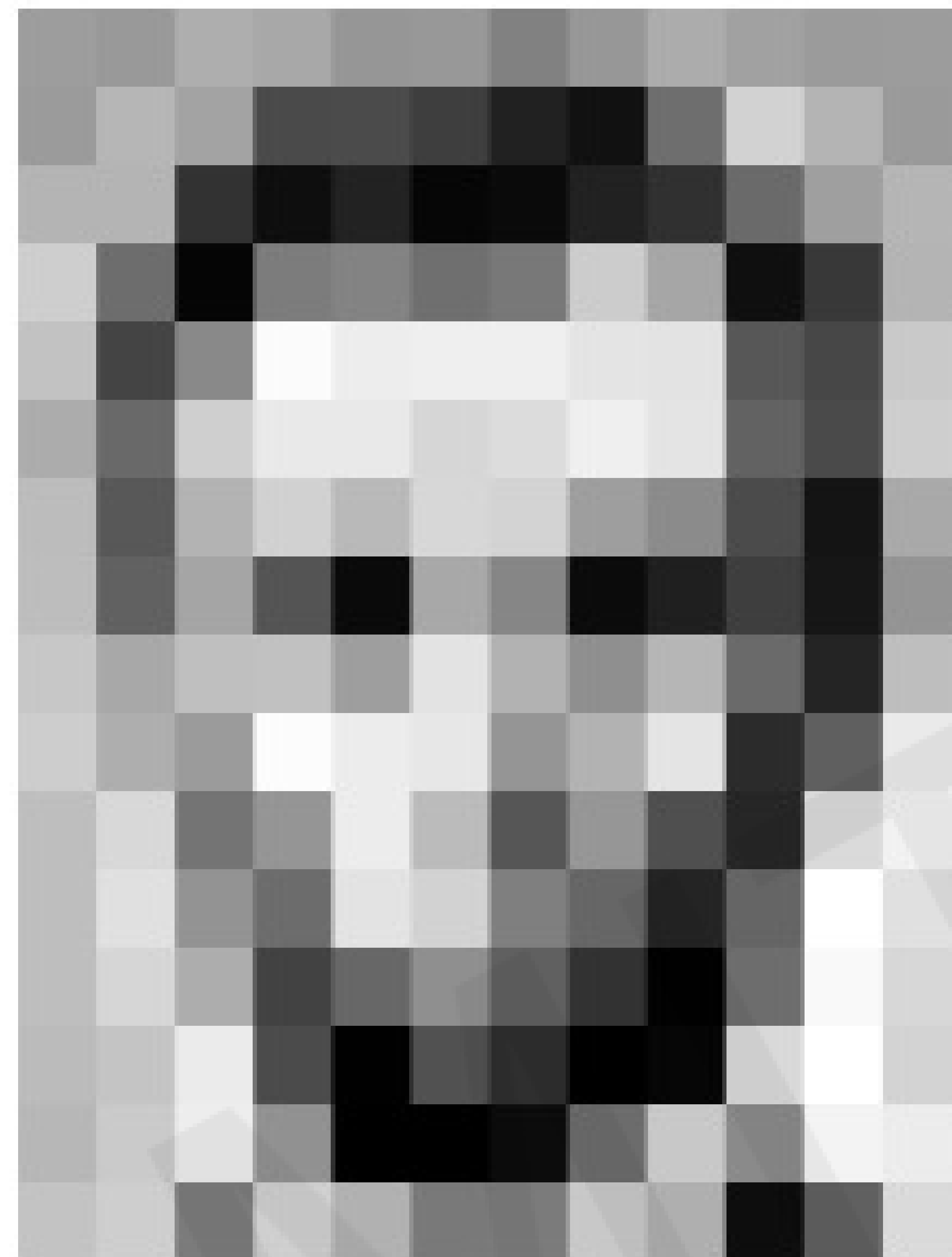

157	153	174	168	150	152	129	151	172	161	155	156
155	182	163	74	75	62	83	17	110	210	180	154
180	180	50	14	84	6	10	33	48	106	159	181
206	109	5	124	131	111	120	204	166	15	56	180
194	68	137	251	257	239	239	228	227	87	71	201
172	106	207	233	233	214	220	239	228	98	74	206
188	88	179	209	185	215	211	158	139	75	20	169
189	97	165	84	10	168	134	11	31	62	22	148
199	168	191	193	158	227	178	143	182	106	36	190
205	174	155	252	236	231	149	178	228	43	95	234
190	216	116	149	236	187	86	150	79	38	218	241
190	224	147	108	227	210	127	102	36	101	255	224
190	214	173	66	103	143	96	50	2	109	249	218
187	196	235	75	1	81	47	0	6	217	255	211
183	202	237	145	0	0	12	108	200	138	243	236
195	206	123	207	177	121	123	200	175	13	96	218

What the computer sees

157	153	174	168	150	152	129	151	172	161	155	156
155	182	163	74	75	62	83	17	110	210	180	154
180	180	50	14	84	6	10	33	48	106	159	181
206	109	5	124	131	111	120	204	166	15	56	180
194	68	137	251	257	239	239	228	227	87	71	201
172	106	207	233	233	214	220	239	228	98	74	206
188	88	179	209	185	215	211	158	139	75	20	169
189	97	165	84	10	168	134	11	31	62	22	148
199	168	191	193	158	227	178	143	182	106	36	190
205	174	155	252	236	231	149	178	228	43	95	234
190	216	116	149	236	187	86	150	79	38	218	241
190	224	147	108	227	210	127	102	36	101	255	224
190	214	173	66	103	143	96	50	2	109	249	218
187	196	235	75	1	81	47	0	6	217	255	211
183	202	237	145	0	0	12	108	200	138	243	236
195	206	123	207	177	121	123	200	175	13	96	218

An image is just a matrix of numbers $[0,255]$!
i.e., $1080 \times 1080 \times 3$ for an RGB image

Tasks in Computer Vision

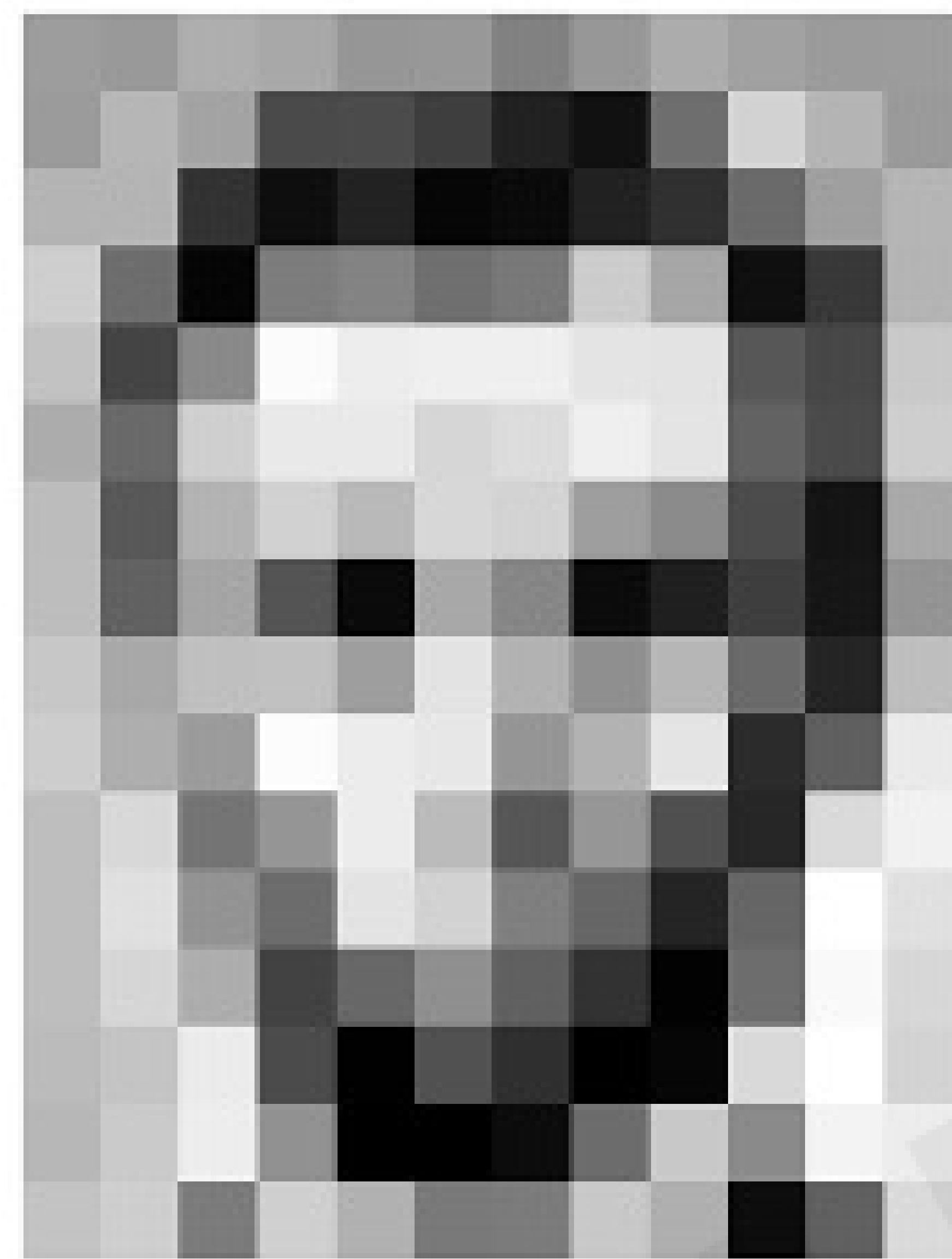

Input Image



167	163	174	168	160	162	129	161	172	161	166	166
166	182	163	74	76	62	33	17	113	213	180	164
180	180	53	14	34	6	10	33	48	106	153	181
200	109	5	124	131	111	120	204	166	15	56	180
164	68	137	201	237	239	239	237	87	71	201	
172	106	207	233	233	214	230	239	239	64	74	206
188	88	179	209	185	215	211	169	139	75	30	169
189	97	165	84	16	168	134	11	31	62	32	148
190	188	181	183	188	227	178	143	182	106	36	190
205	174	185	232	236	231	149	178	228	43	95	234
190	210	116	148	236	187	86	150	79	38	218	241
190	234	147	108	227	210	127	102	36	101	205	234
190	214	173	66	103	142	96	63	3	108	249	216
187	196	236	75	1	81	47	0	6	217	265	211
183	202	237	145	0	0	12	108	200	138	243	236
195	206	123	207	177	121	123	200	175	13	96	218

Pixel Representation

classification

Lincoln

Washington

Jefferson

Obama

0.8

0.1

0.05

0.05

- **Regression:** output variable takes continuous value
- **Classification:** output variable takes class label. Can produce probability of belonging to a particular class

High Level Feature Detection

Let's identify key features in each image category



Nose,
Eyes,
Mouth



Wheels,
License Plate,
Headlights



Door,
Windows,
Steps

Manual Feature Extraction



Problems?

Manual Feature Extraction

Domain knowledge

Define features

Detect features to classify

Viewpoint variation



Scale variation



Deformation



Occlusion



Illumination conditions

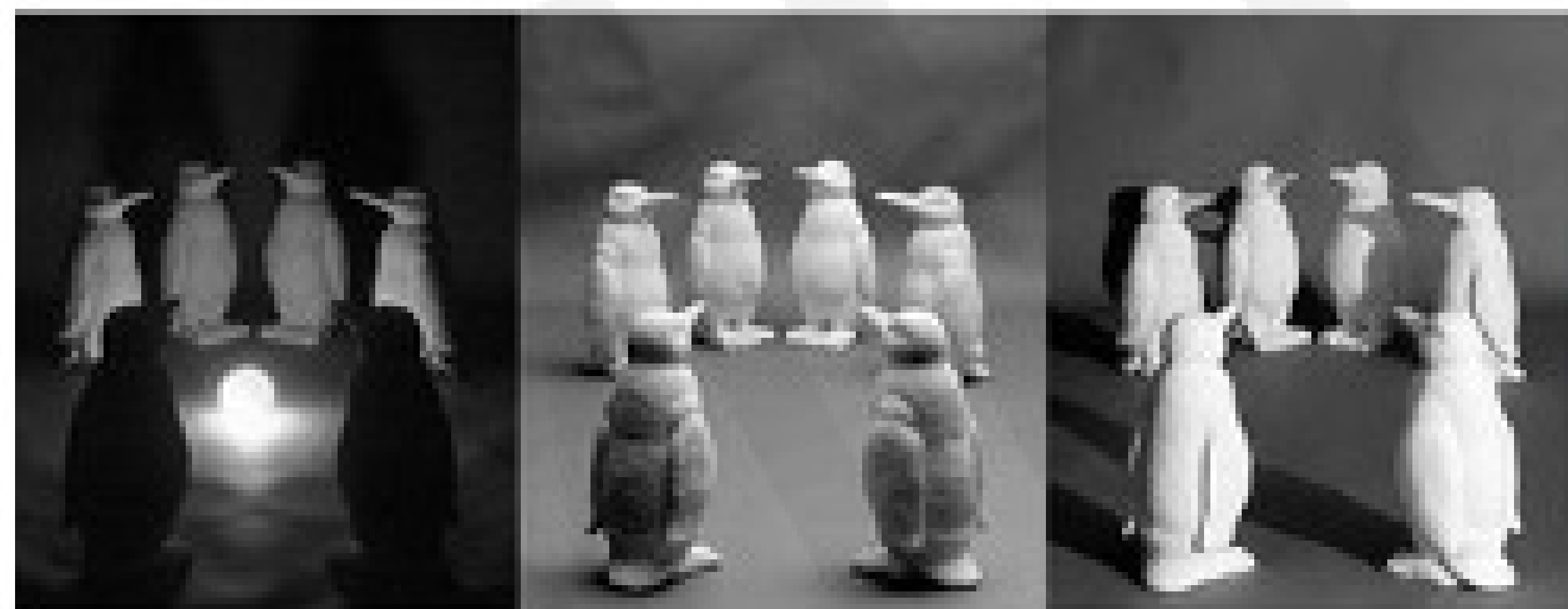

Background clutter



Intra-class variation



Manual Feature Extraction

Domain knowledge

Define features

Detect features to classify

Viewpoint variation



Scale variation



Deformation



Occlusion



Illumination conditions

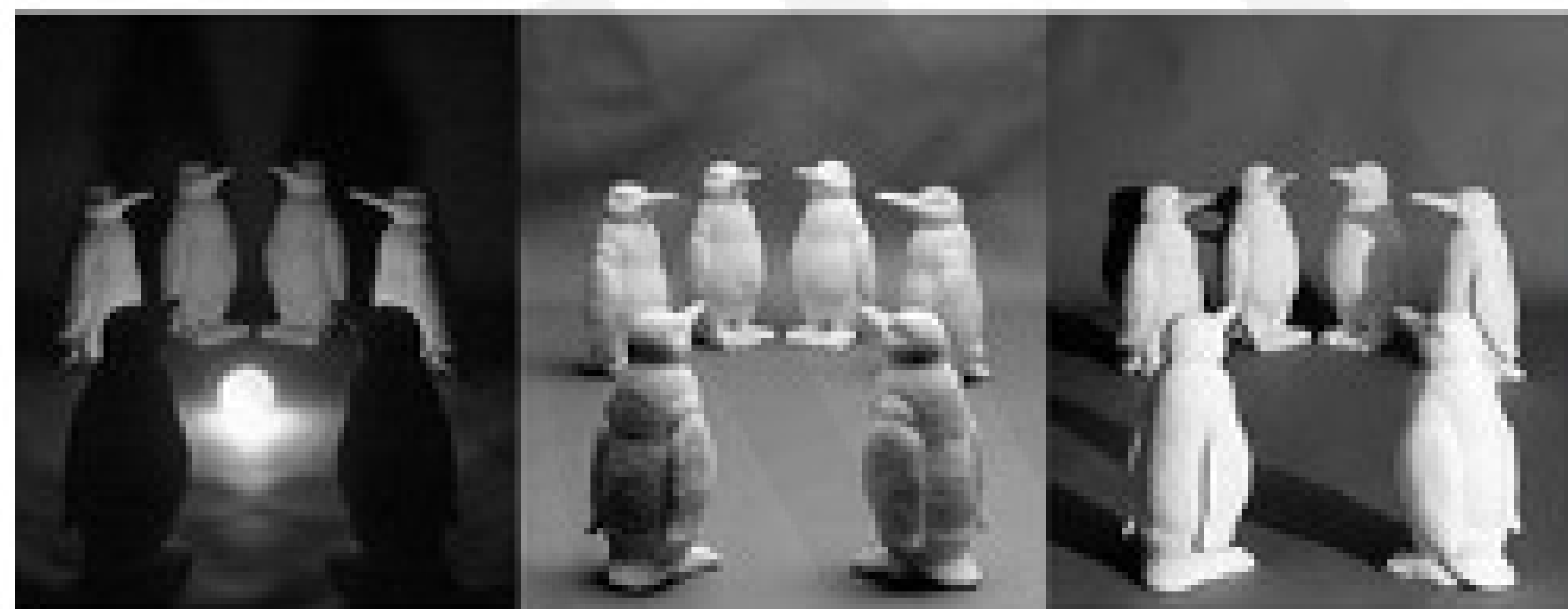

Background clutter



Intra-class variation



Learning Feature Representations

Can we learn a **hierarchy of features** directly from the data instead of hand engineering?

Low level features

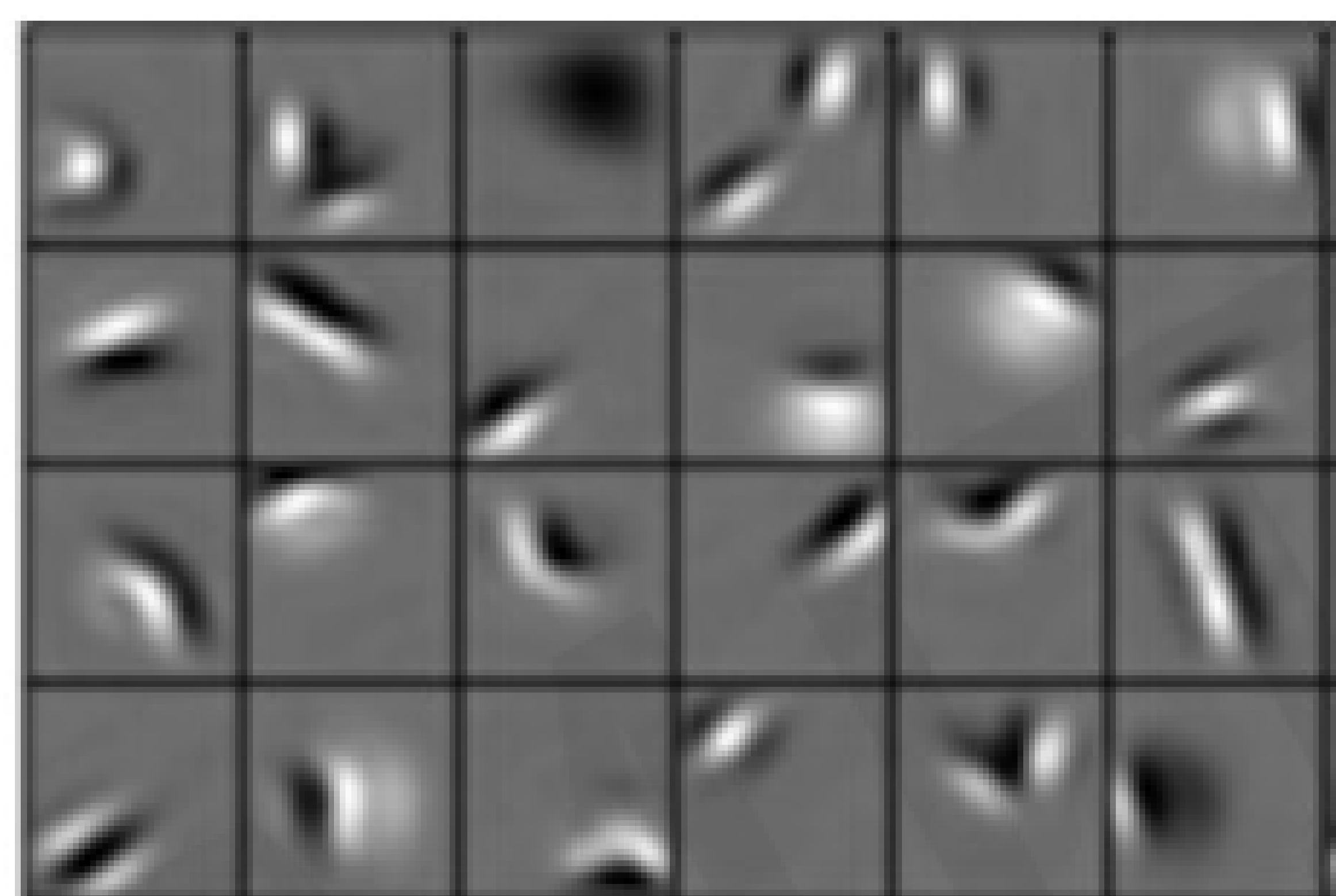

Edges, dark spots

Mid level features

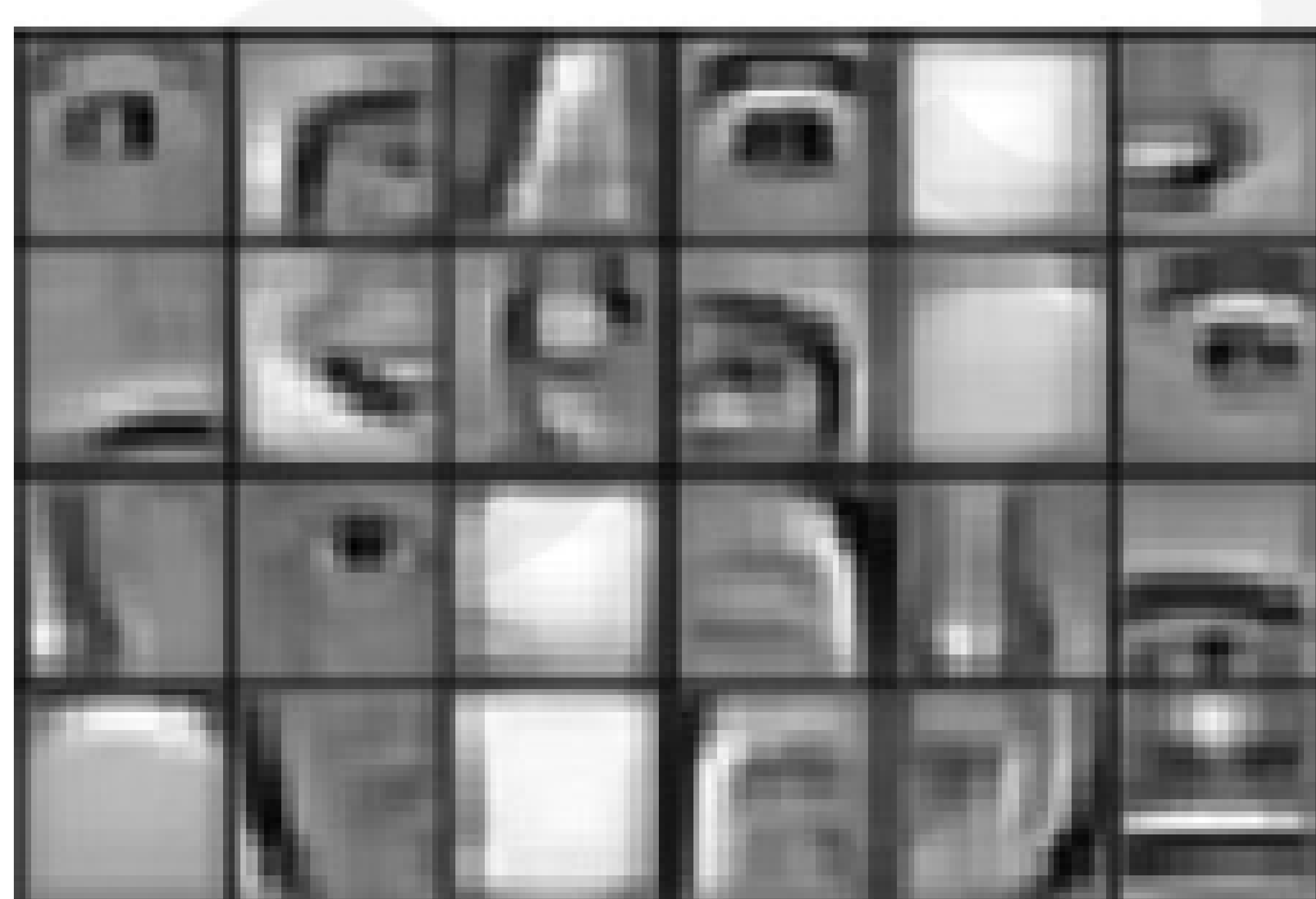

Eyes, ears, nose

High level features



Facial structure

Learning Visual Features

Fully Connected Neural Network

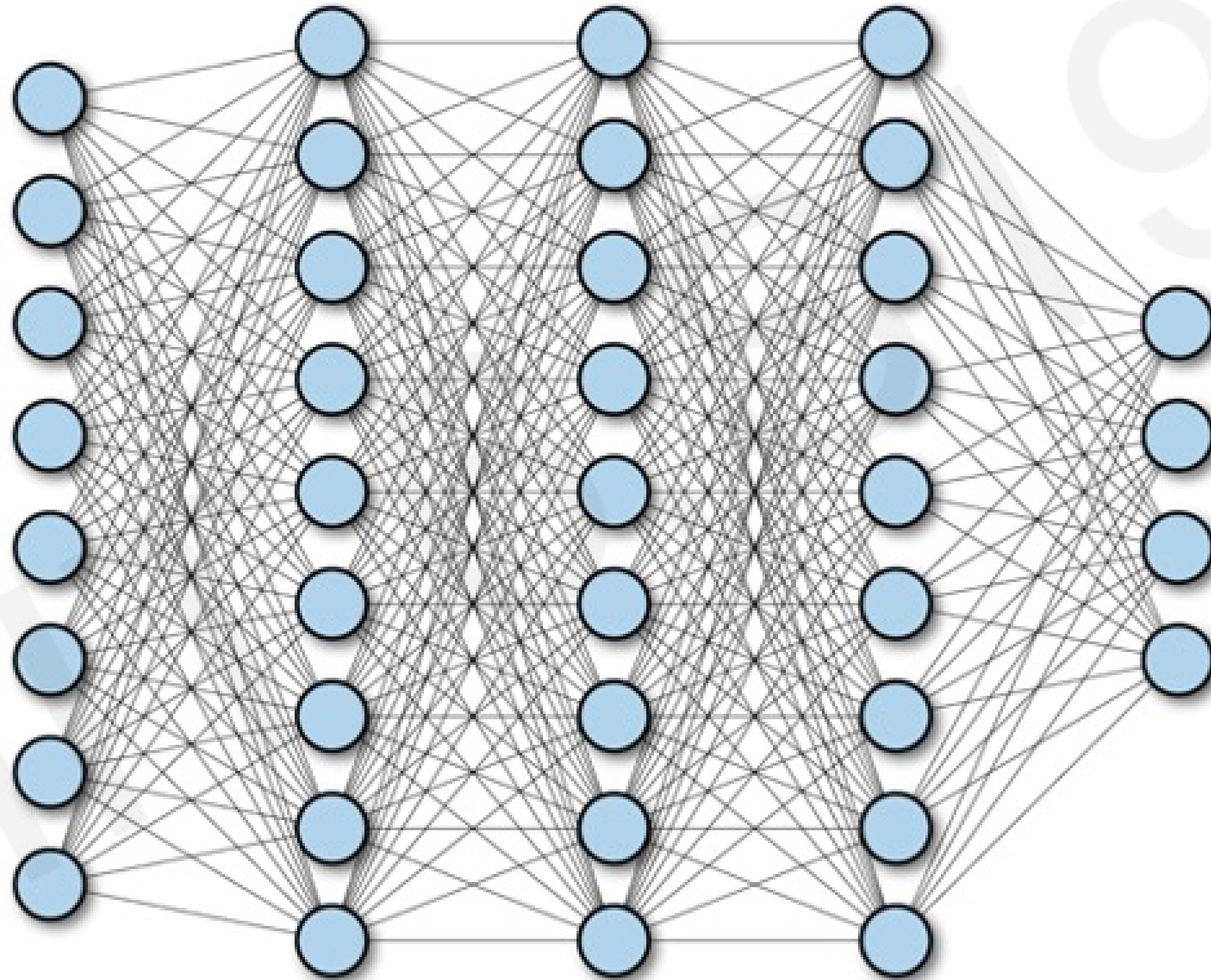

Fully Connected Neural Network

Input:

- 2D image
- Vector of pixel values

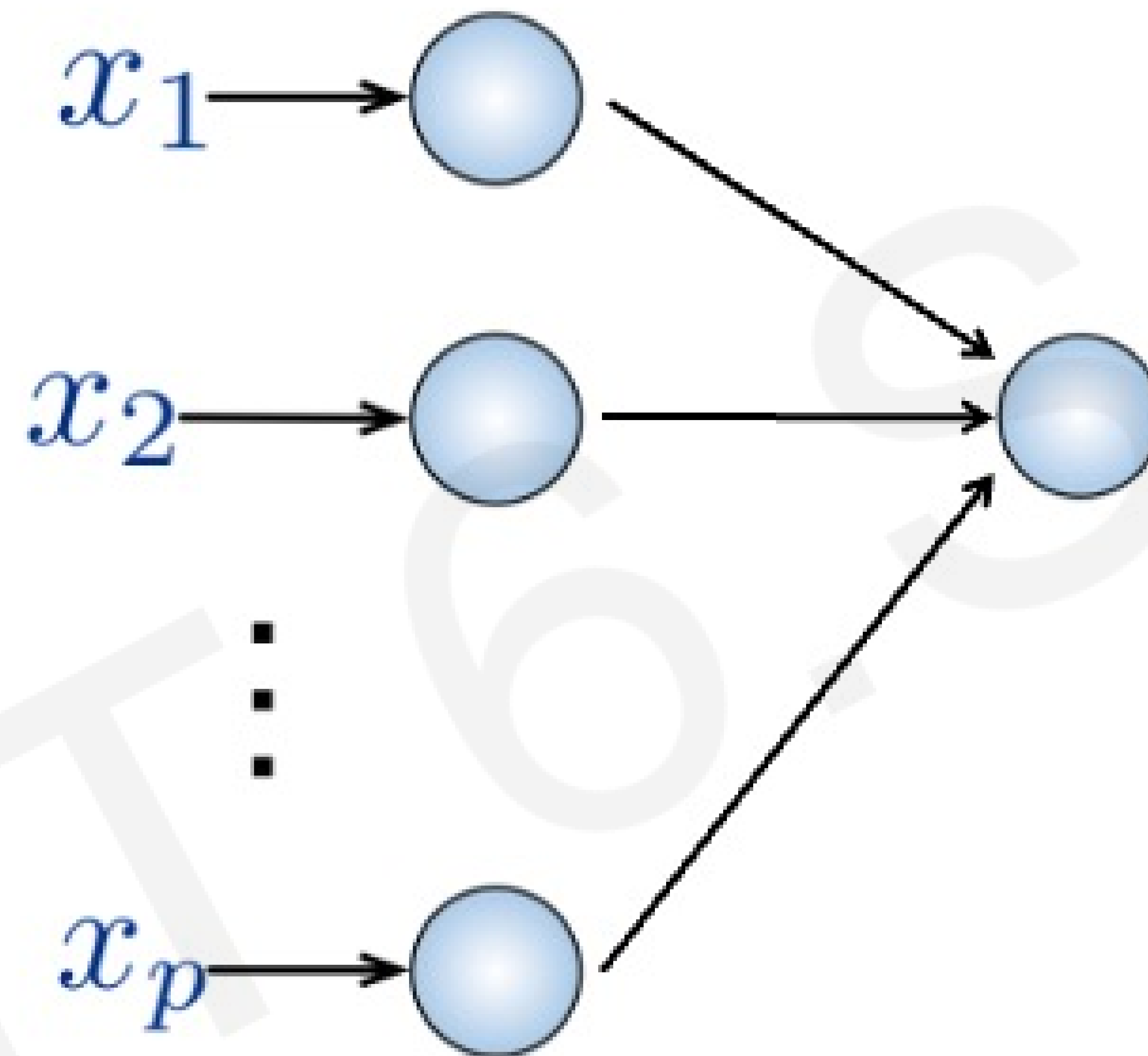

Fully Connected:

- Connect neuron in hidden layer to all neurons in input layer
- No spatial information!
- And many, many parameters!

Fully Connected Neural Network

Input:

- 2D image
- Vector of pixel values

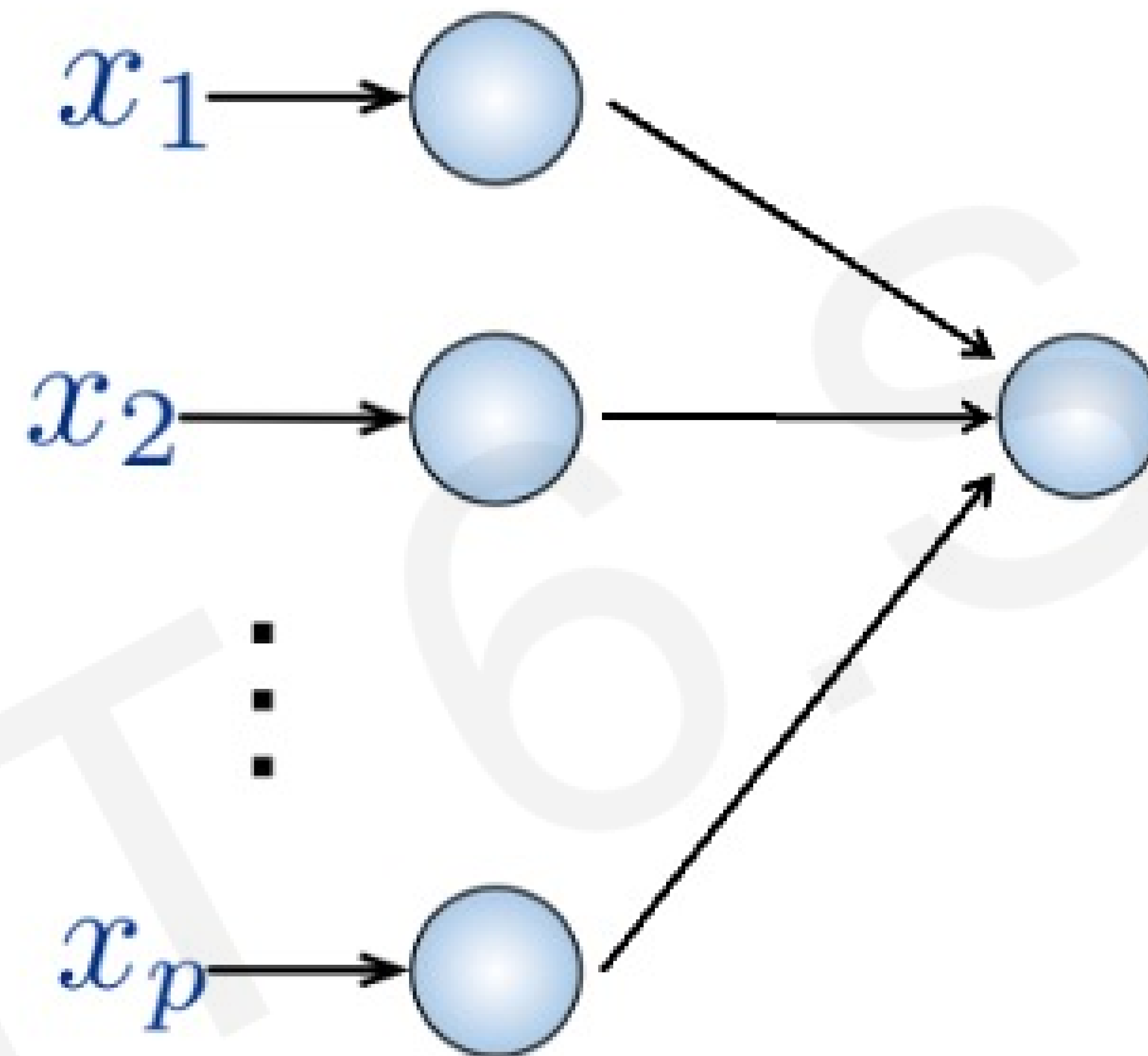

Fully Connected:

- Connect neuron in hidden layer to all neurons in input layer
- No spatial information!
- And many, many parameters!

How can we use **spatial structure** in the input to inform the architecture of the network?

Using Spatial Structure

Input: 2D image.
Array of pixel values

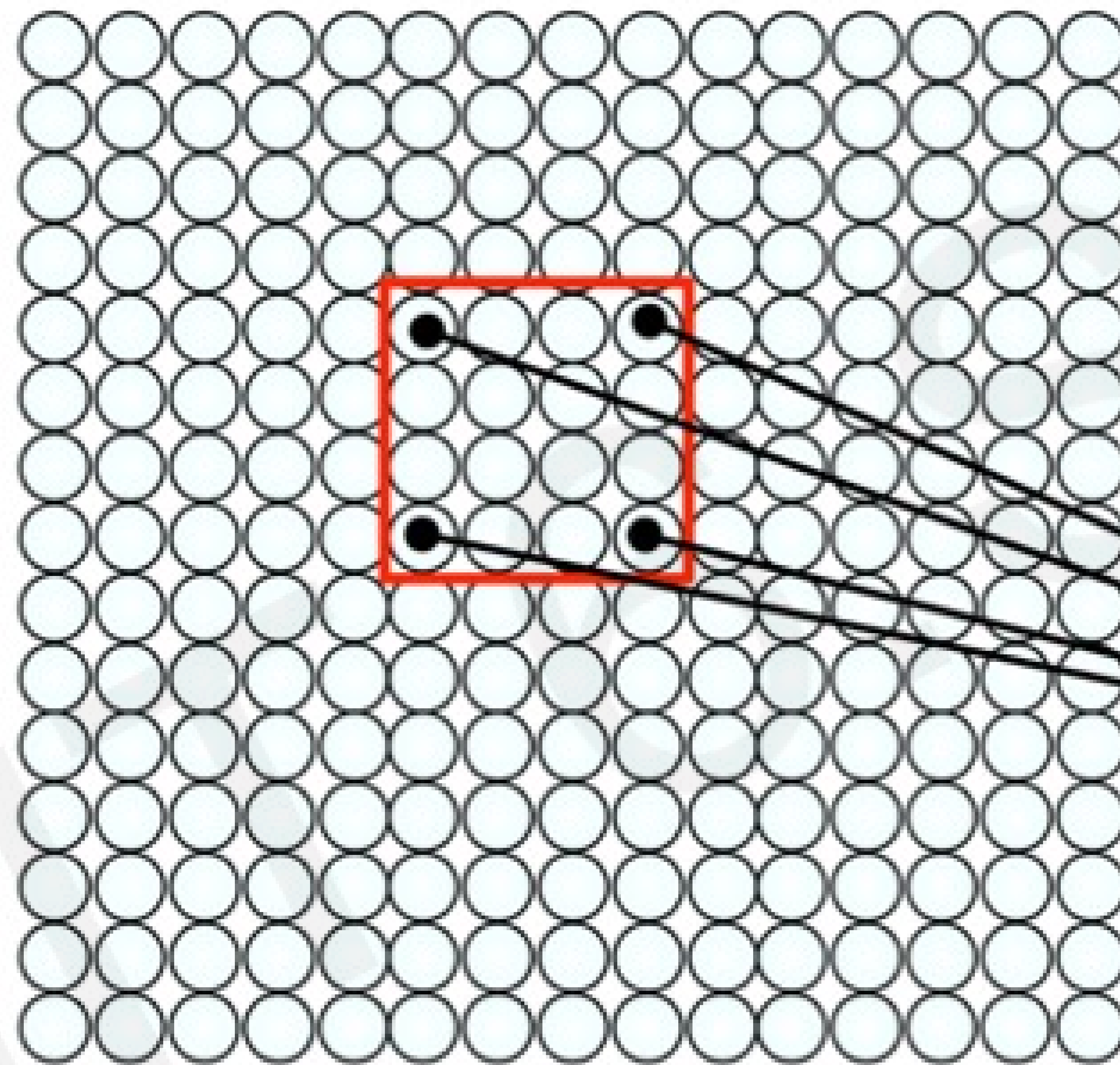

Idea: connect patches of input
to neurons in hidden layer.
Neuron connected to region of
input. Only "sees" these values.

Using Spatial Structure

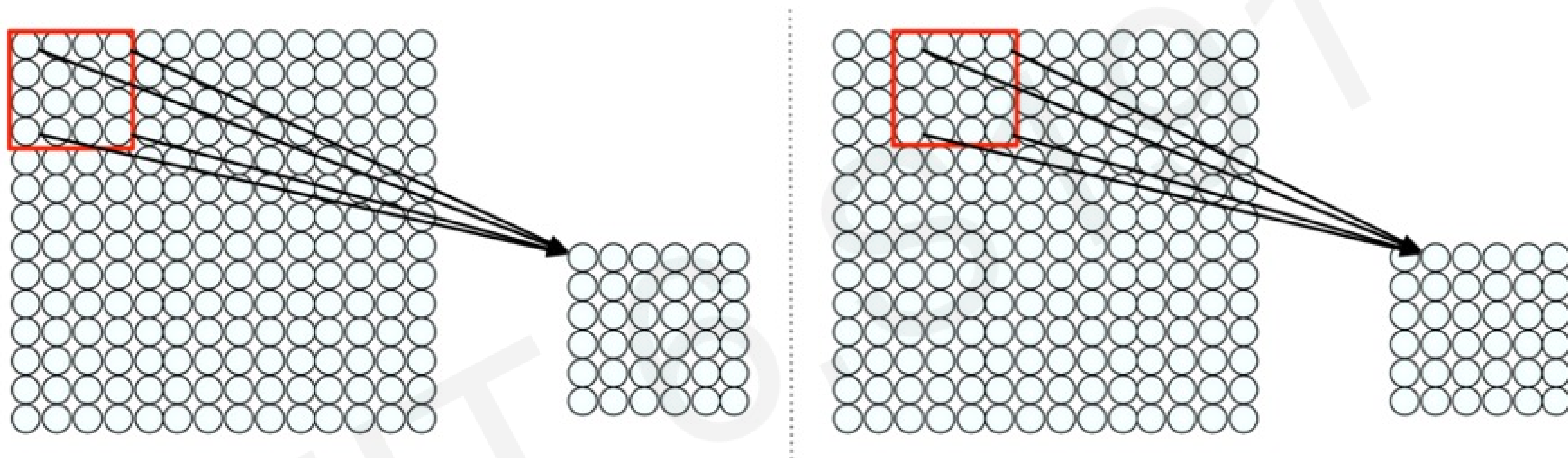

Connect patch in input layer to a single neuron in subsequent layer.

Use a sliding window to define connections.

How can we **weight** the patch to detect particular features?

Applying Filters to Extract Features

- 1) Apply a set of weights – a filter – to extract **local features**
- 2) Use **multiple filters** to extract different features
- 3) Spatially **share** parameters of each filter
(features that matter in one part of the input should matter elsewhere)

Feature Extraction with Convolution

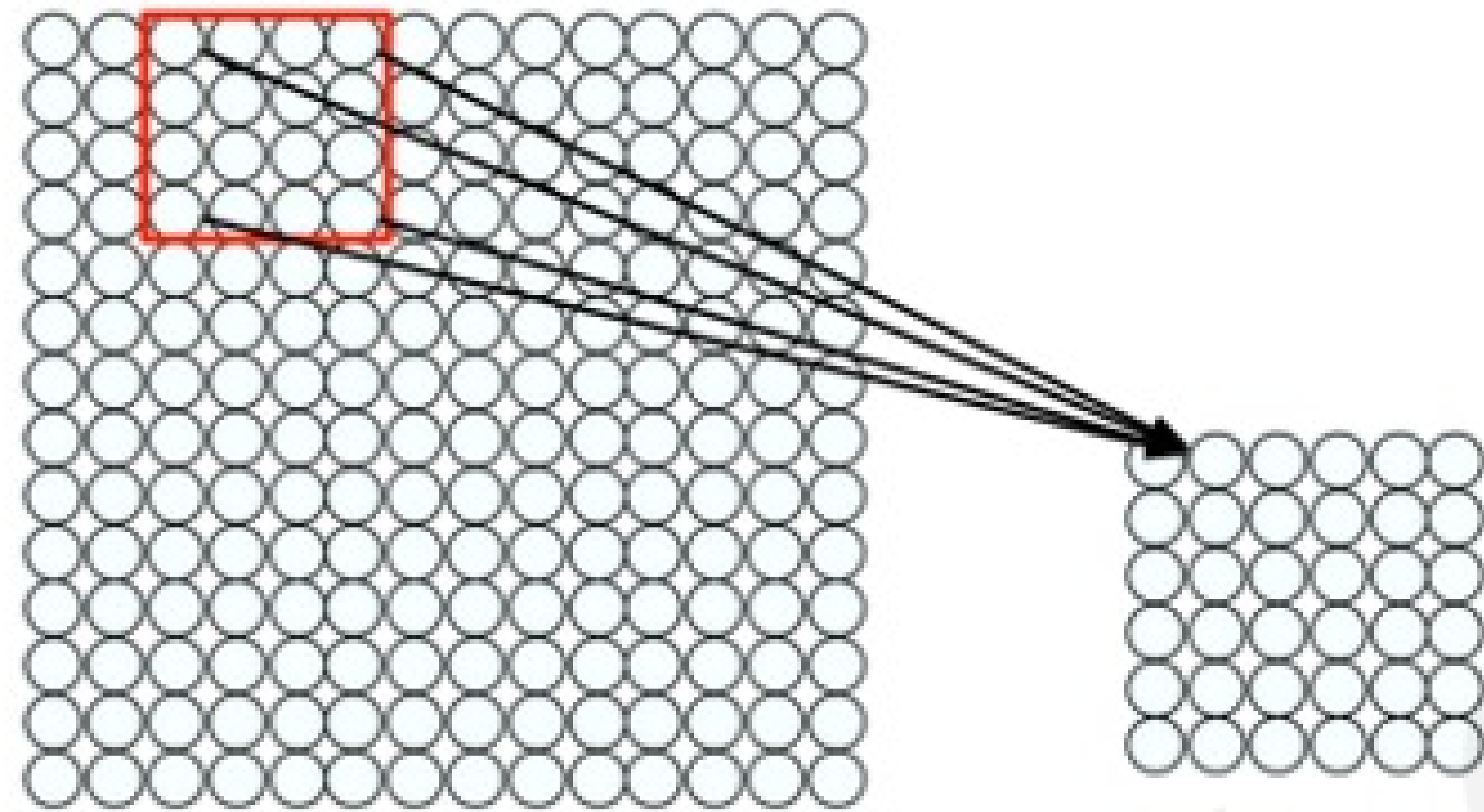

- Filter of size 4x4 : 16 different weights
- Apply this same filter to 4x4 patches in input
- Shift by 2 pixels for next patch

This “patchy” operation is **convolution**

- 1) Apply a set of weights – a filter – to extract **local features**
- 2) Use **multiple filters** to extract different features
- 3) **Spatially share** parameters of each filter

Feature Extraction and Convolution

A Case Study

X or X?

-1	-1	-1	-1	-1	-1	-1	-1	-1
-1	1	-1	-1	-1	-1	-1	1	-1
-1	-1	1	-1	-1	-1	1	-1	-1
-1	-1	-1	1	-1	1	-1	-1	-1
-1	-1	-1	-1	1	-1	-1	-1	-1
-1	-1	-1	1	-1	1	-1	-1	-1
-1	-1	1	-1	-1	-1	1	-1	-1
-1	1	-1	-1	-1	-1	-1	1	-1
-1	-1	-1	-1	-1	-1	-1	-1	-1



-1	-1	-1	-1	-1	-1	-1	-1	-1
-1	-1	-1	-1	-1	-1	1	-1	-1
-1	1	-1	-1	-1	1	-1	-1	-1
-1	-1	1	1	-1	1	-1	-1	-1
-1	-1	-1	-1	1	-1	-1	-1	-1
-1	-1	-1	1	-1	1	1	-1	-1
-1	-1	-1	1	-1	-1	-1	1	-1
-1	-1	1	-1	-1	-1	-1	-1	-1
-1	-1	-1	-1	-1	-1	-1	-1	-1

Image is represented as matrix of pixel values... and computers are literal!
We want to be able to classify an X as an X even if it's shifted, shrunk, rotated, deformed.

Features of X

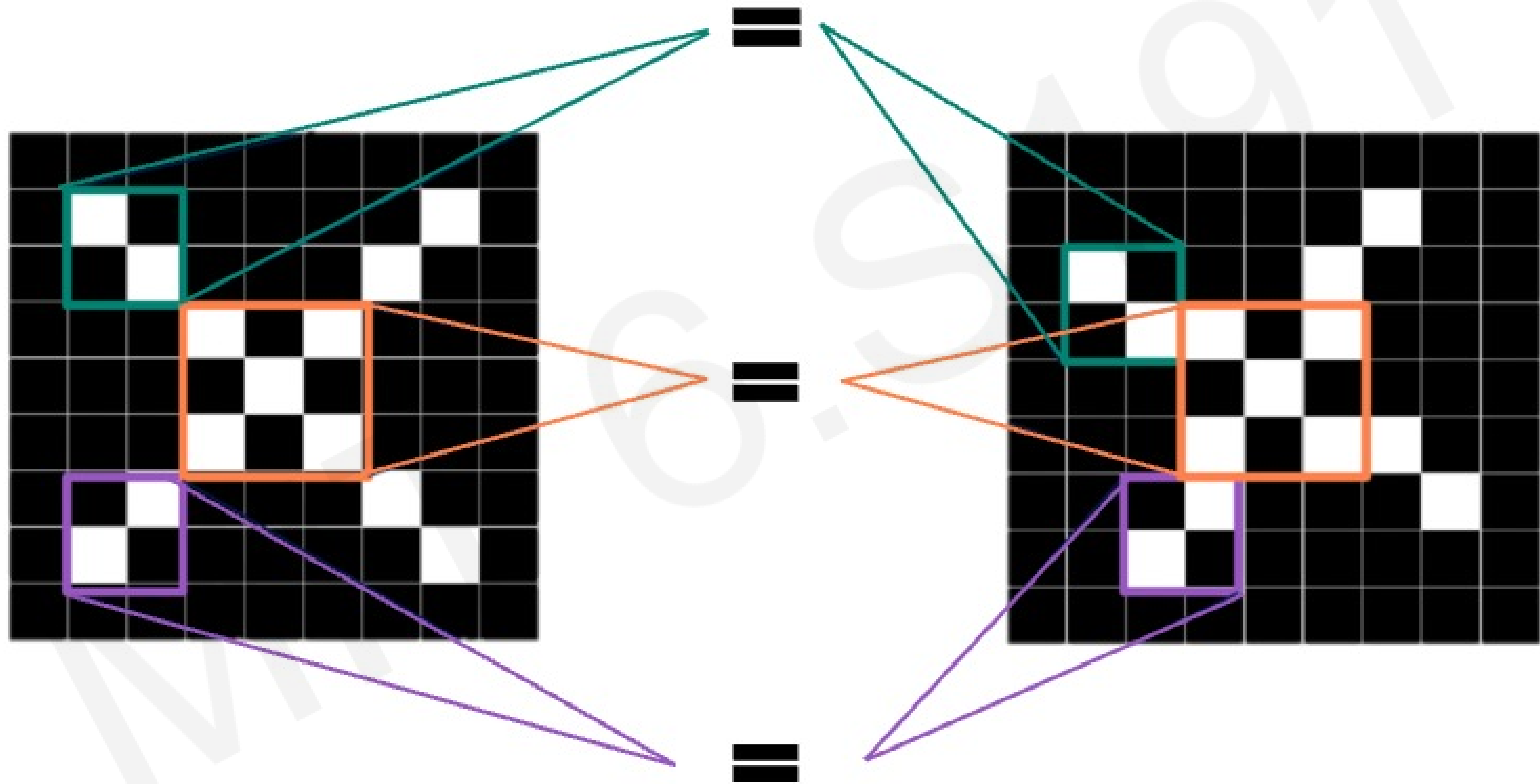

Filters to Detect X Features

filters

1	-1	-1
-1	1	-1
-1	-1	1

1	-1	1
-1	1	-1
1	-1	1

-1	-1	1
-1	1	-1
1	-1	-1

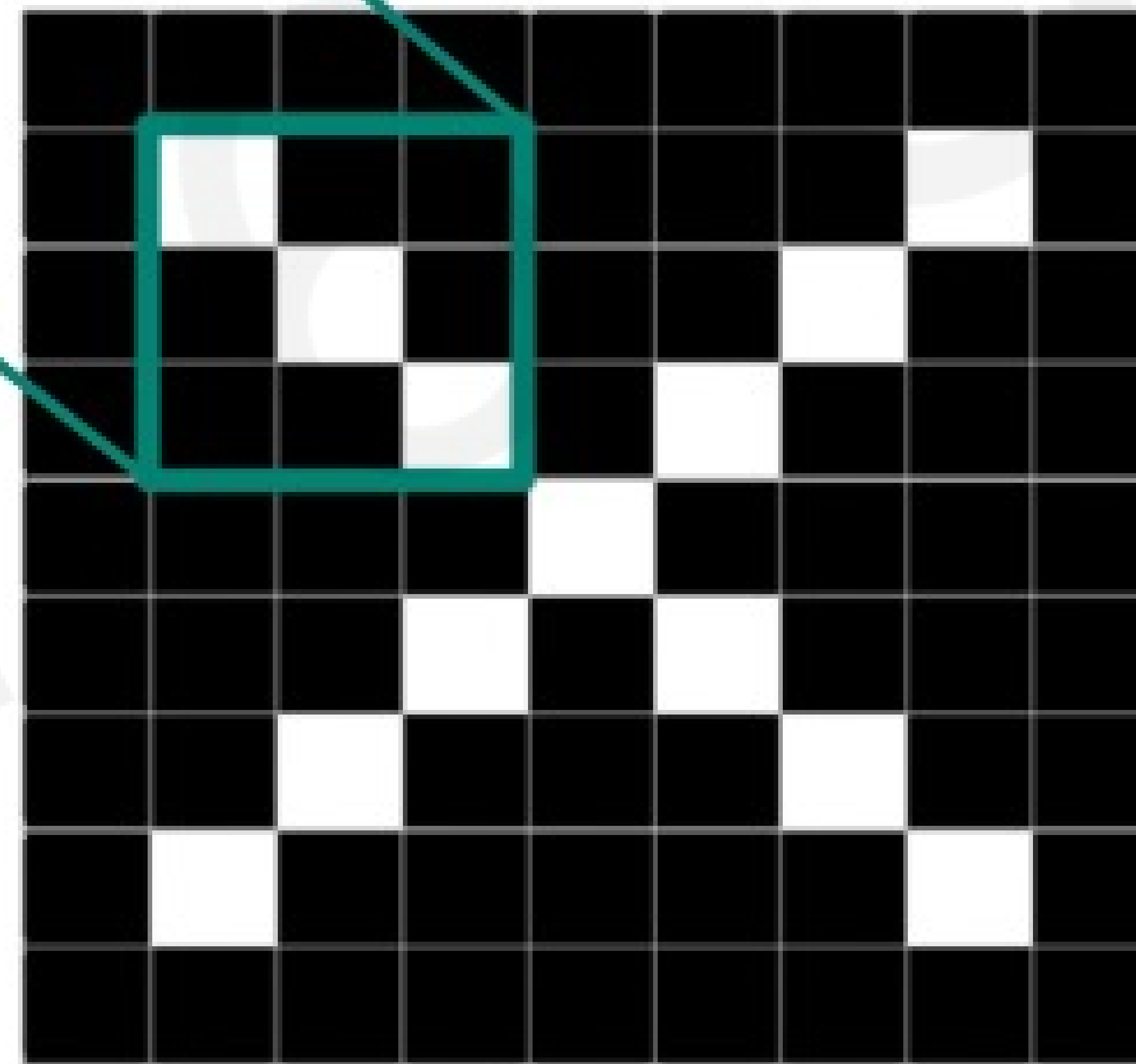

The Convolution Operation

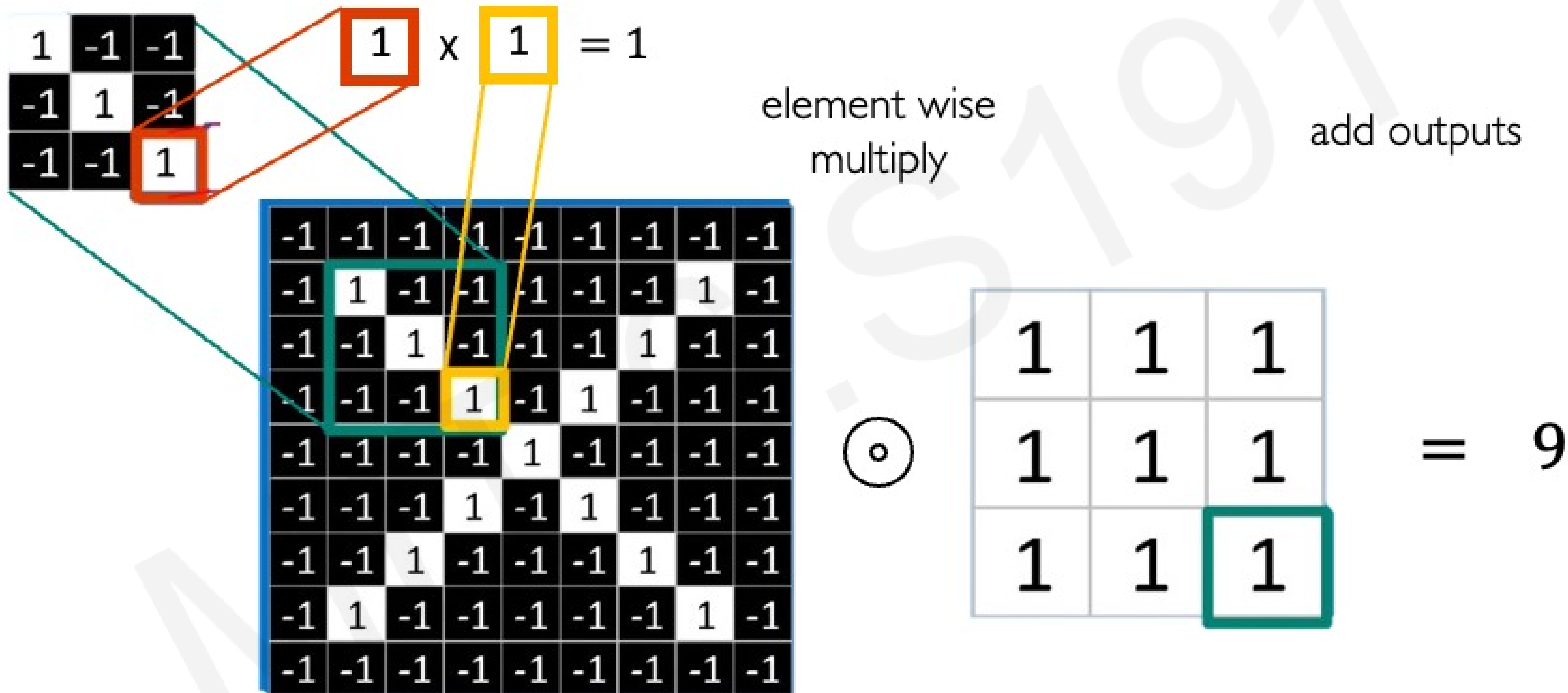

The Convolution Operation

Suppose we want to compute the convolution of a 5x5 image and a 3x3 filter:

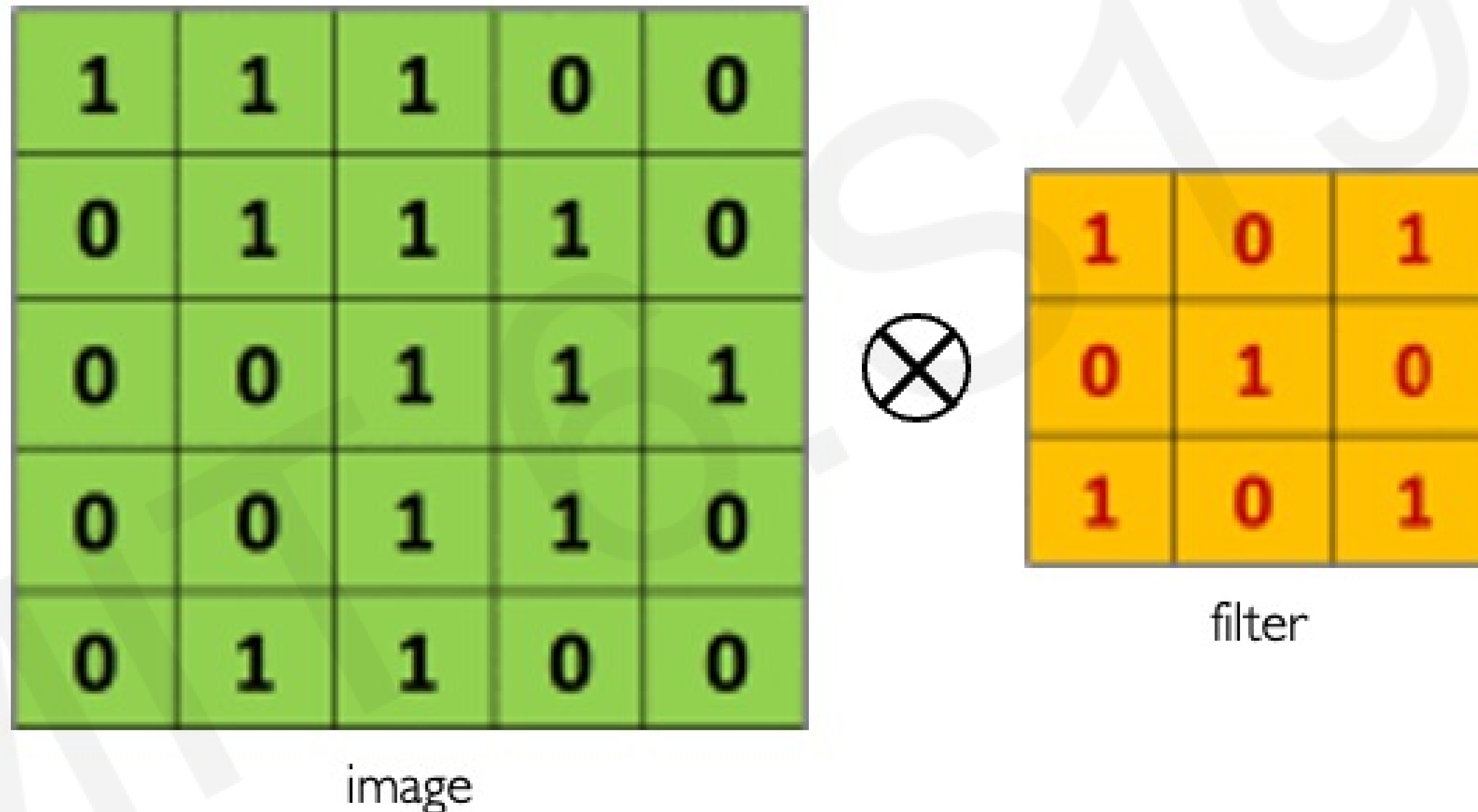

We slide the 3x3 filter over the input image, element-wise multiply, and add the outputs...

The Convolution Operation

We slide the 3x3 filter over the input image, element-wise multiply, and add the outputs:

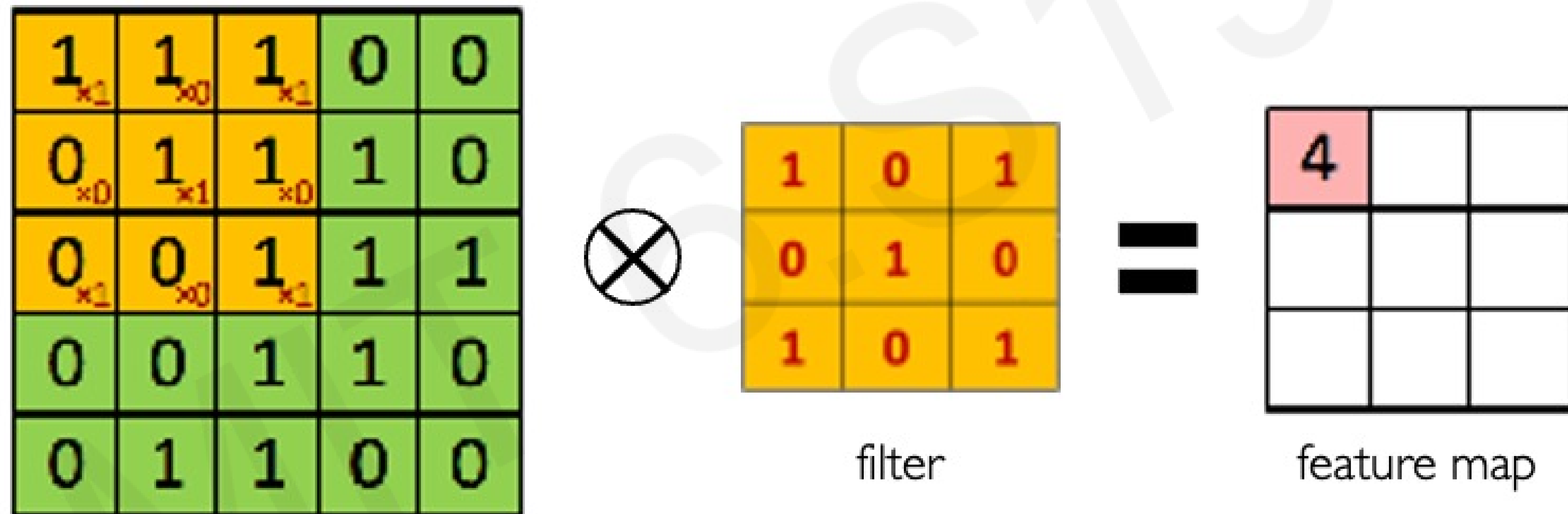

The Convolution Operation

We slide the 3x3 filter over the input image, element-wise multiply, and add the outputs:

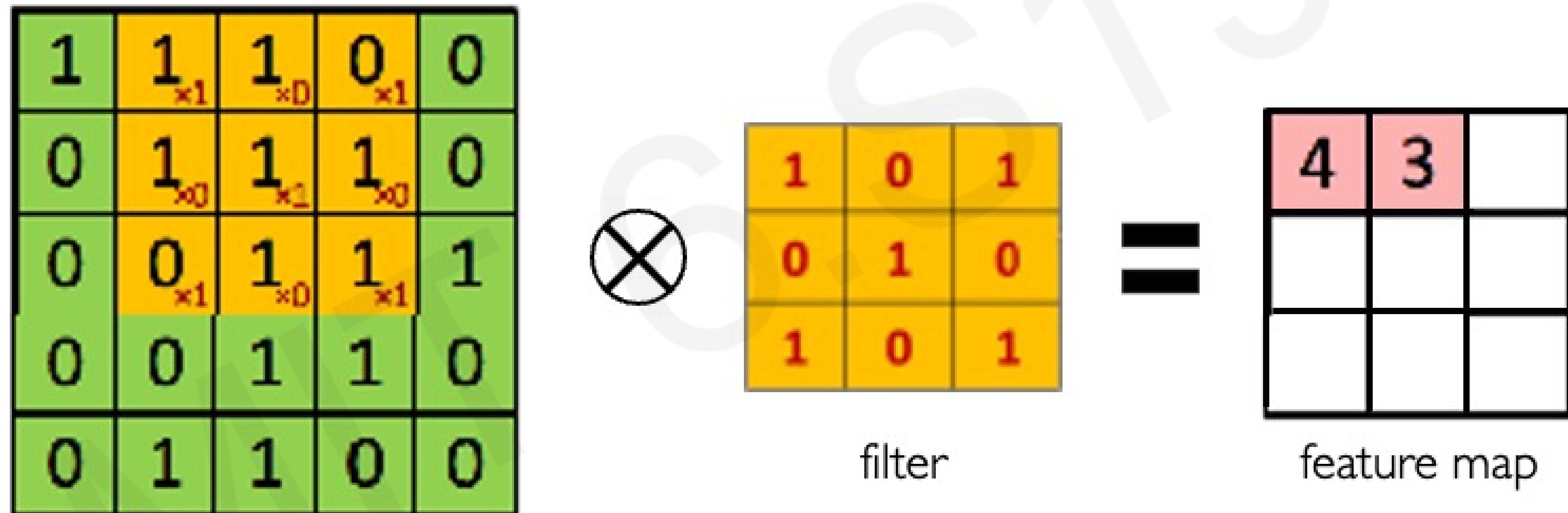

The Convolution Operation

We slide the 3x3 filter over the input image, element-wise multiply, and add the outputs:

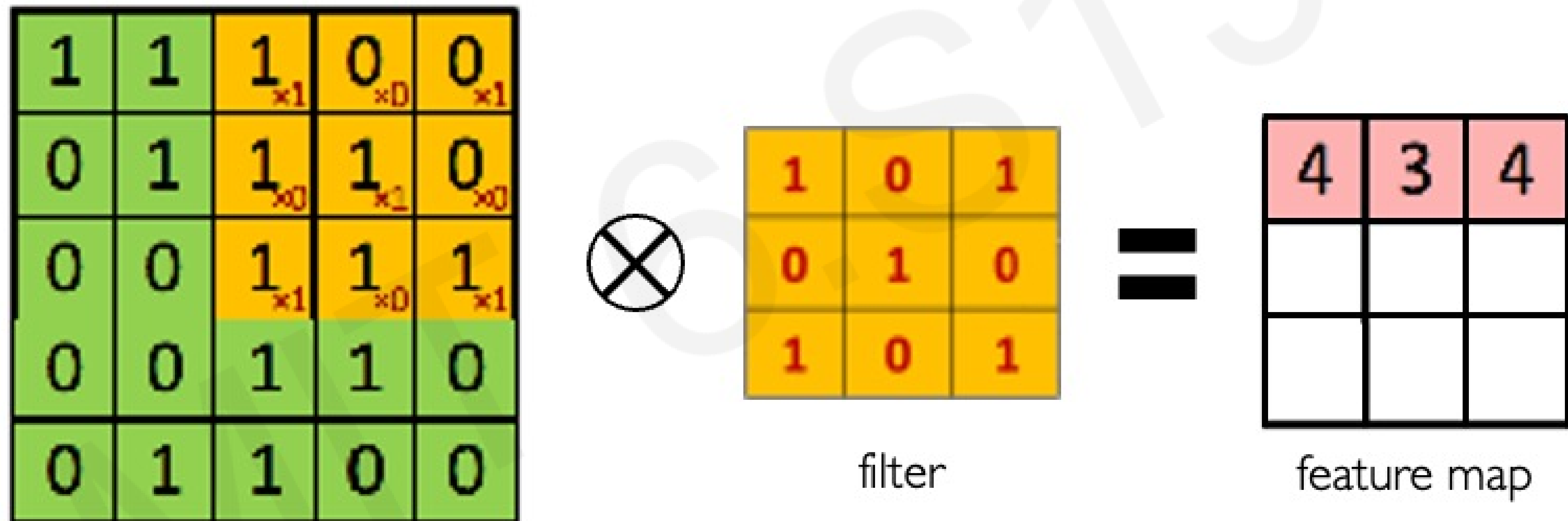

The Convolution Operation

We slide the 3x3 filter over the input image, element-wise multiply, and add the outputs:

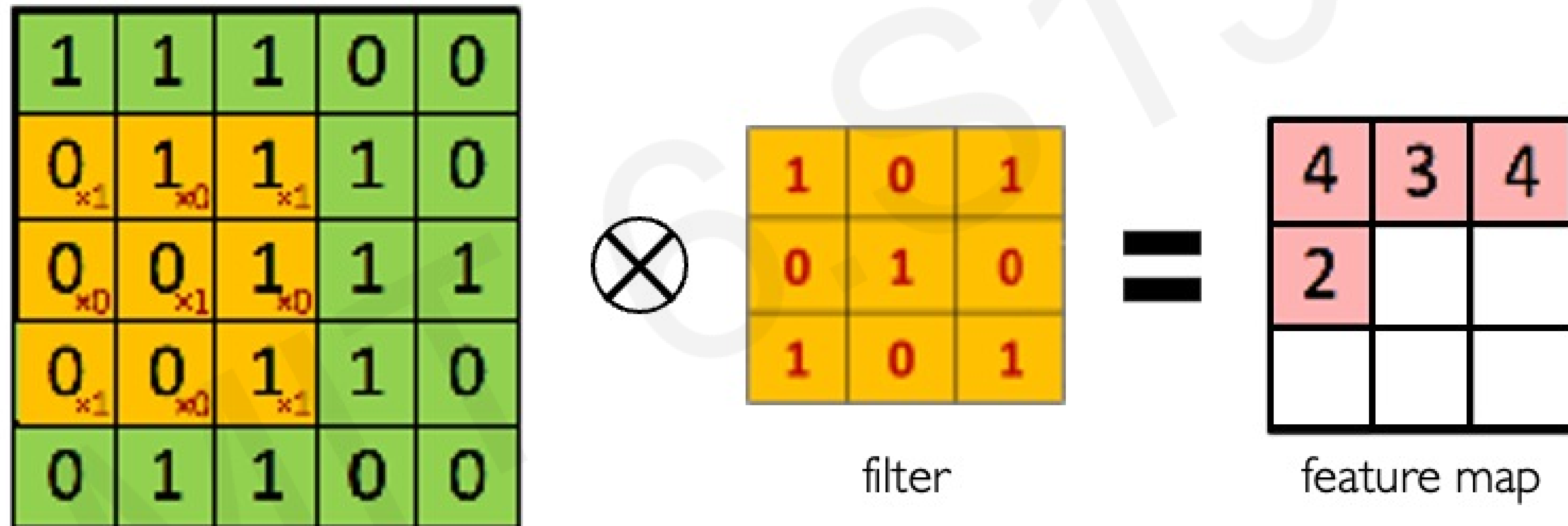

The Convolution Operation

We slide the 3x3 filter over the input image, element-wise multiply, and add the outputs:

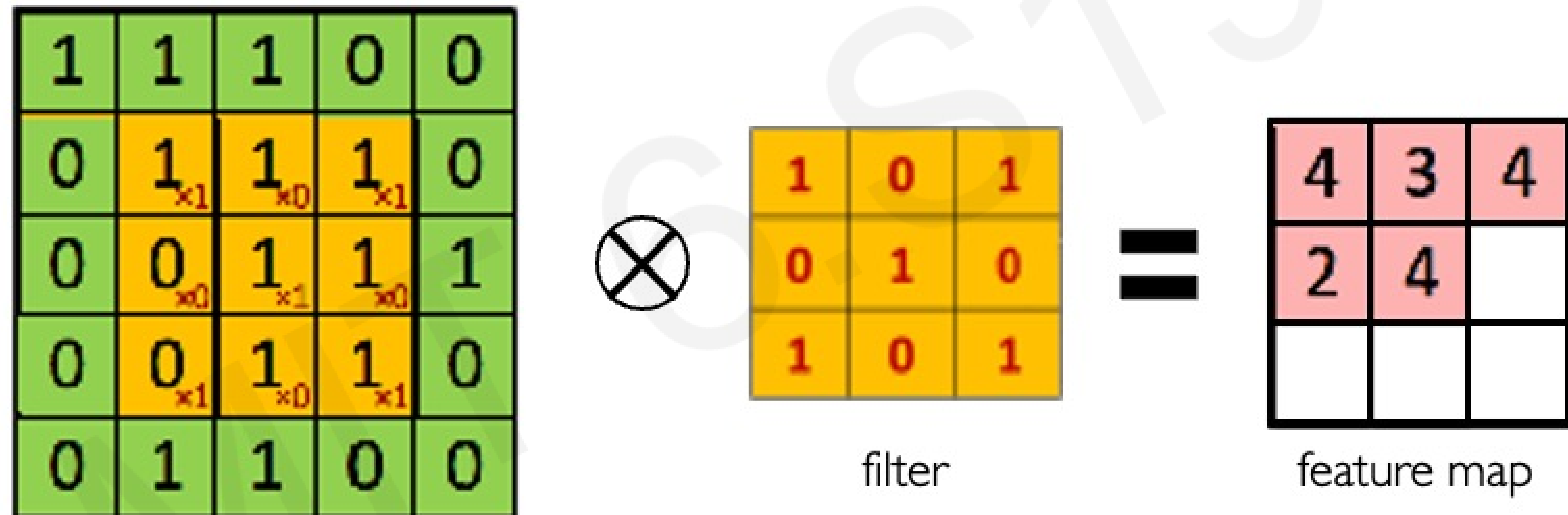

The Convolution Operation

We slide the 3x3 filter over the input image, element-wise multiply, and add the outputs:

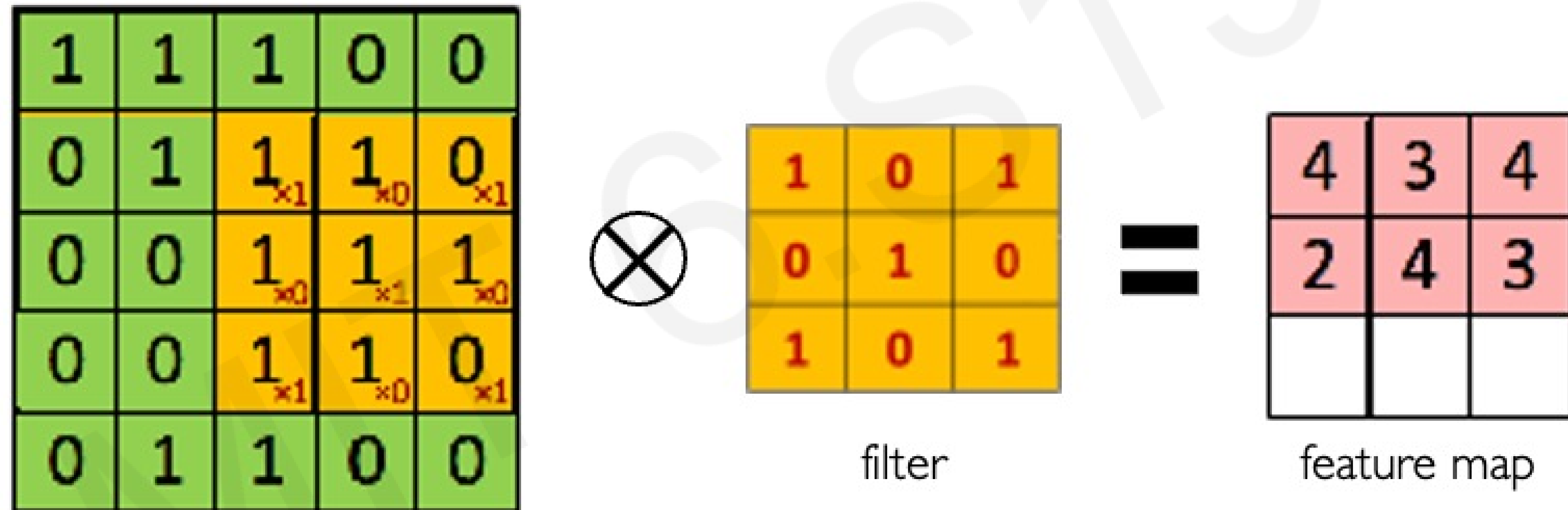

The Convolution Operation

We slide the 3x3 filter over the input image, element-wise multiply, and add the outputs:

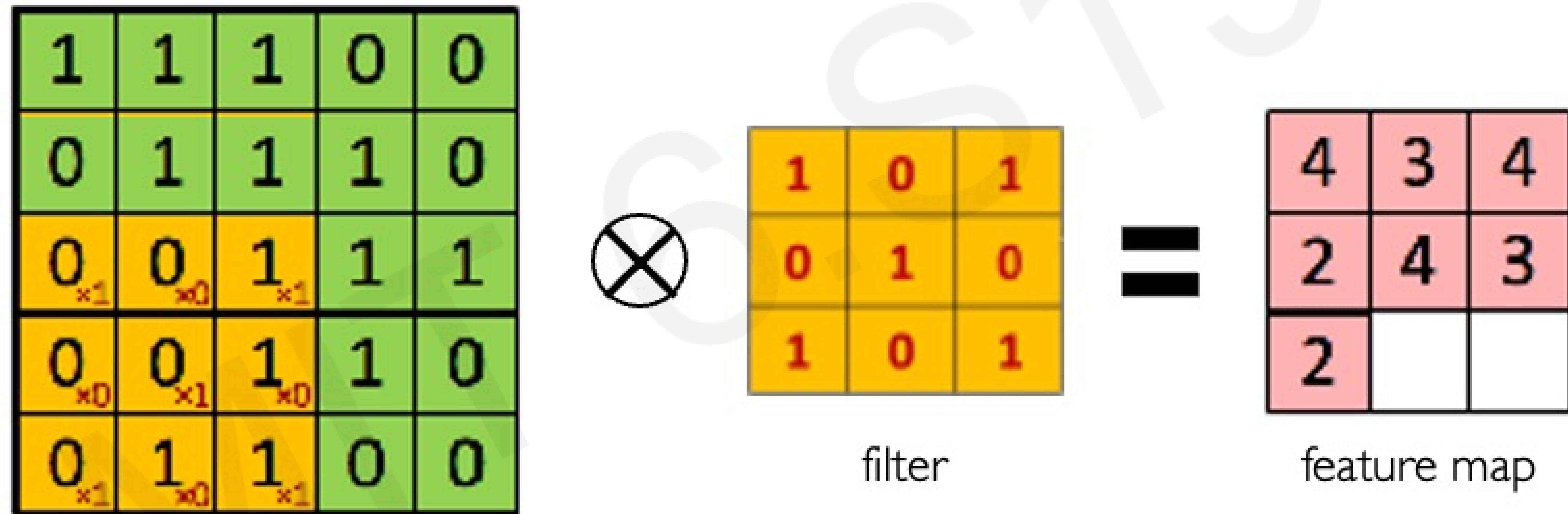

The Convolution Operation

We slide the 3x3 filter over the input image, element-wise multiply, and add the outputs:

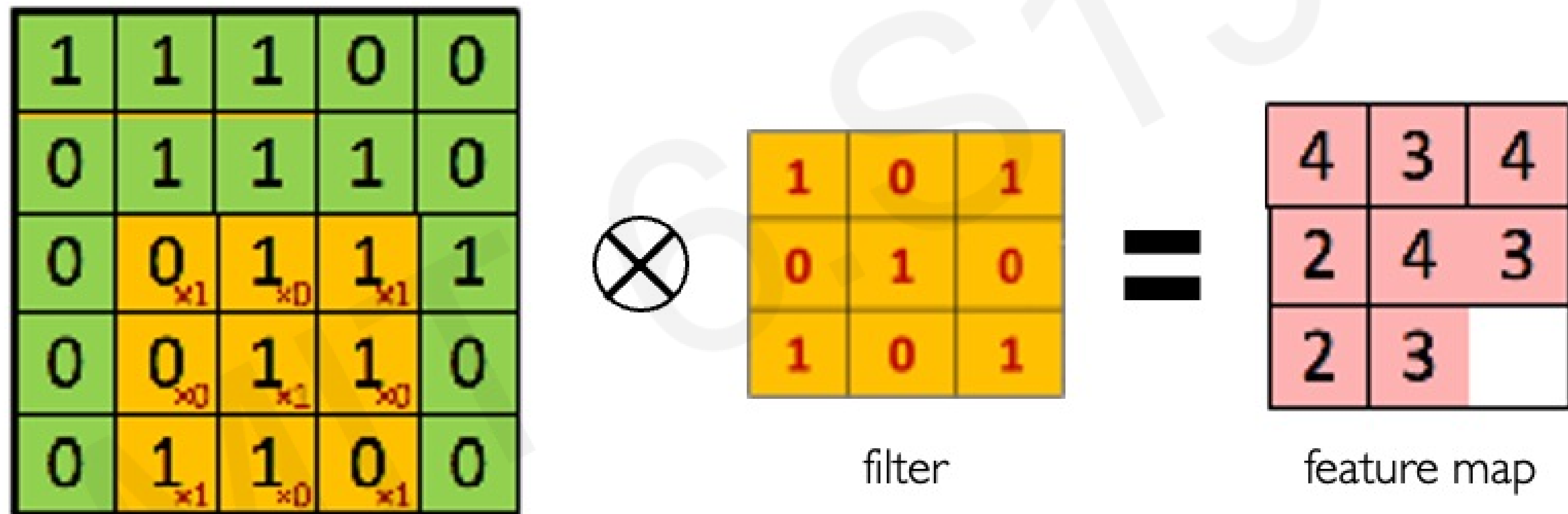

The Convolution Operation

We slide the 3x3 filter over the input image, element-wise multiply, and add the outputs:

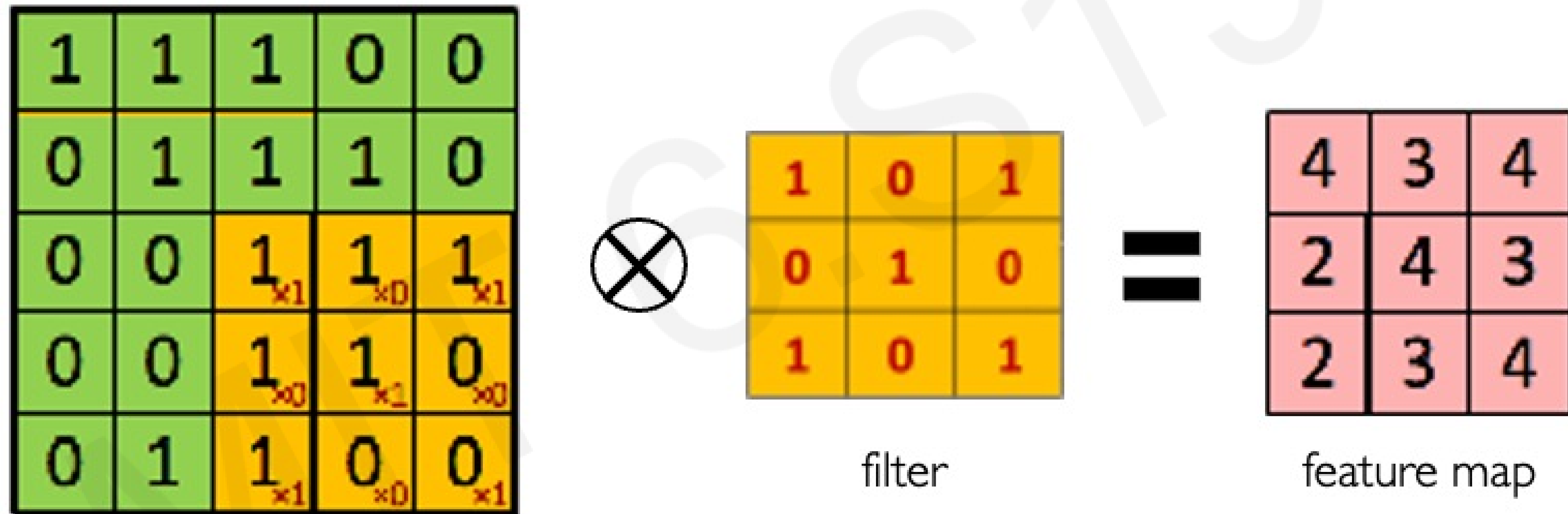

Producing Feature Maps



Original



Sharpen



Edge Detect



"Strong" Edge Detect

Feature Extraction with Convolution

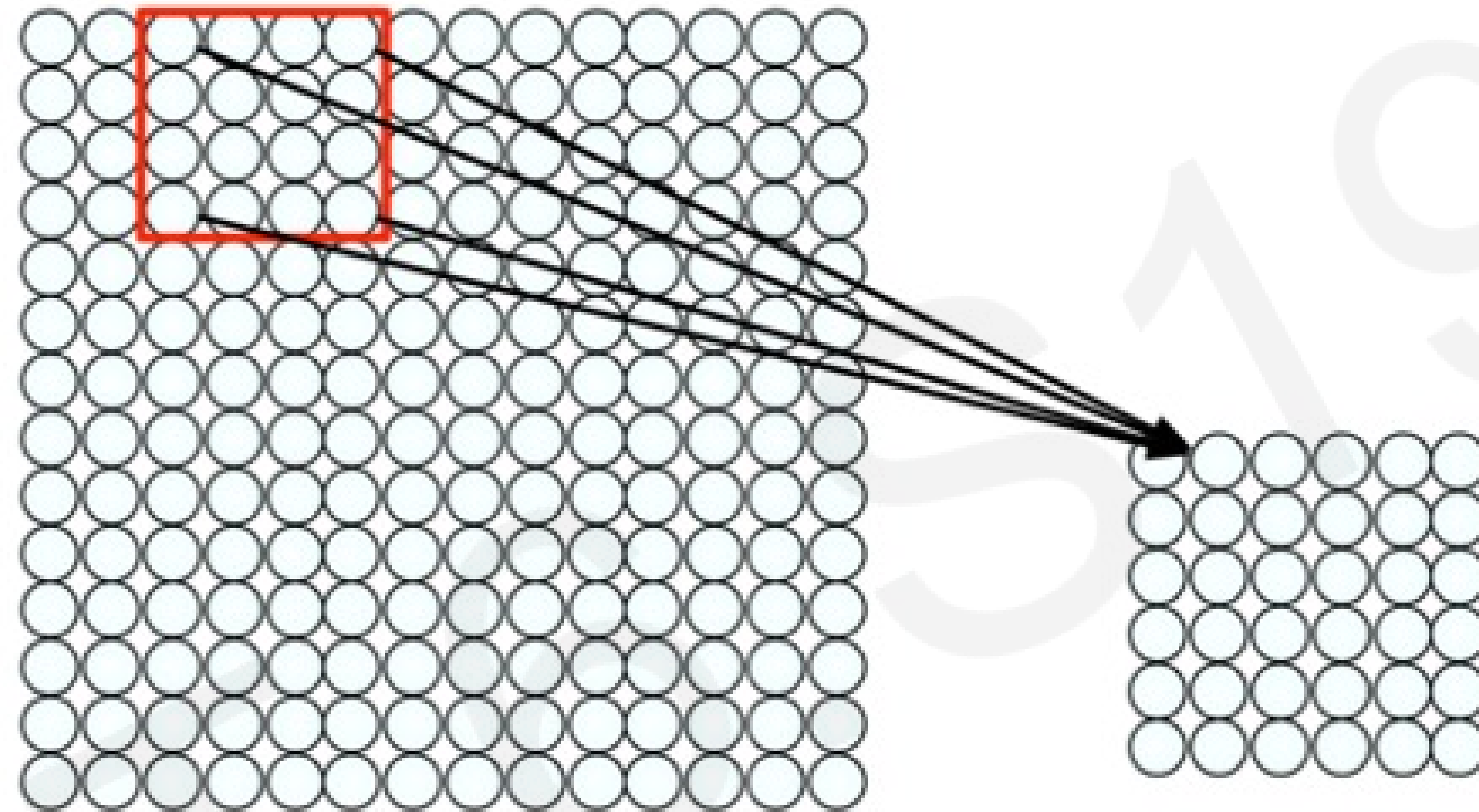

- 1) Apply a set of weights – a filter – to extract **local features**
- 2) Use **multiple filters** to extract different features
- 3) **Spatially share** parameters of each filter

Convolutional Neural Networks (CNNs)

CNNs for Classification

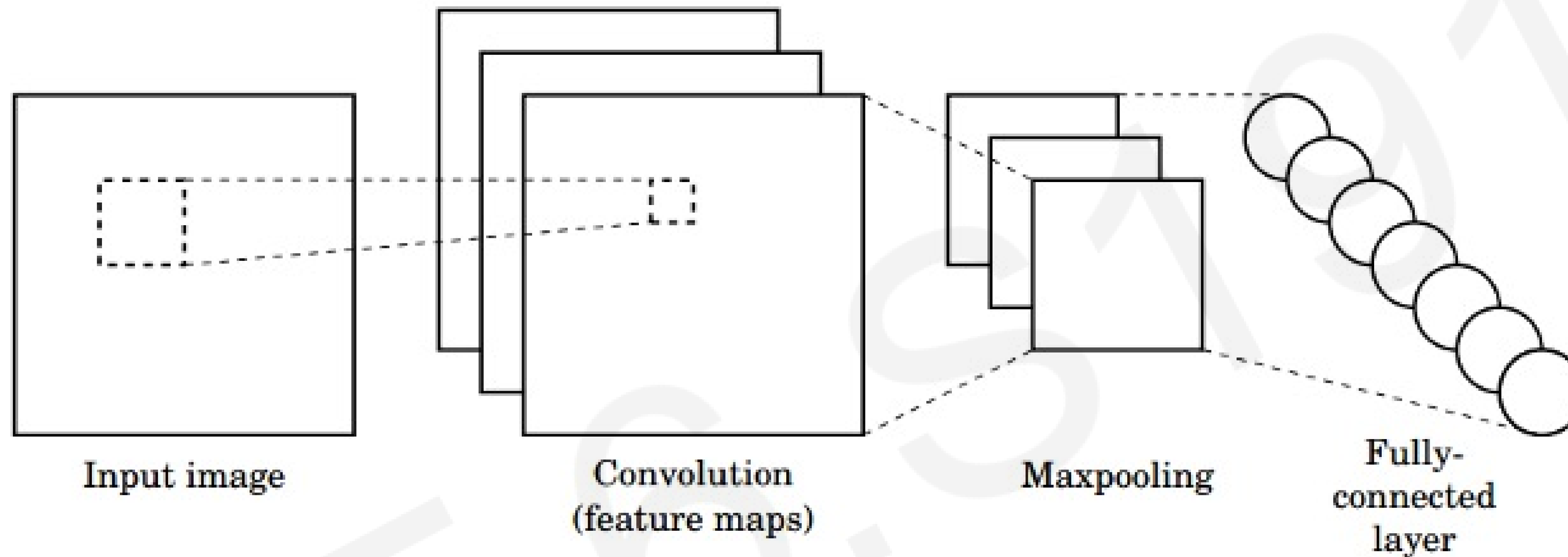

1. **Convolution:** Apply filters to generate feature maps.

2. **Non-linearity:** Often ReLU.

3. **Pooling:** Downsampling operation on each feature map.

 `tf.keras.layers.Conv2D`

 `tf.keras.activations.*`

 `tf.keras.layers.MaxPool2D`

Train model with image data.

Learn weights of filters in convolutional layers.

Convolutional Layers: Local Connectivity

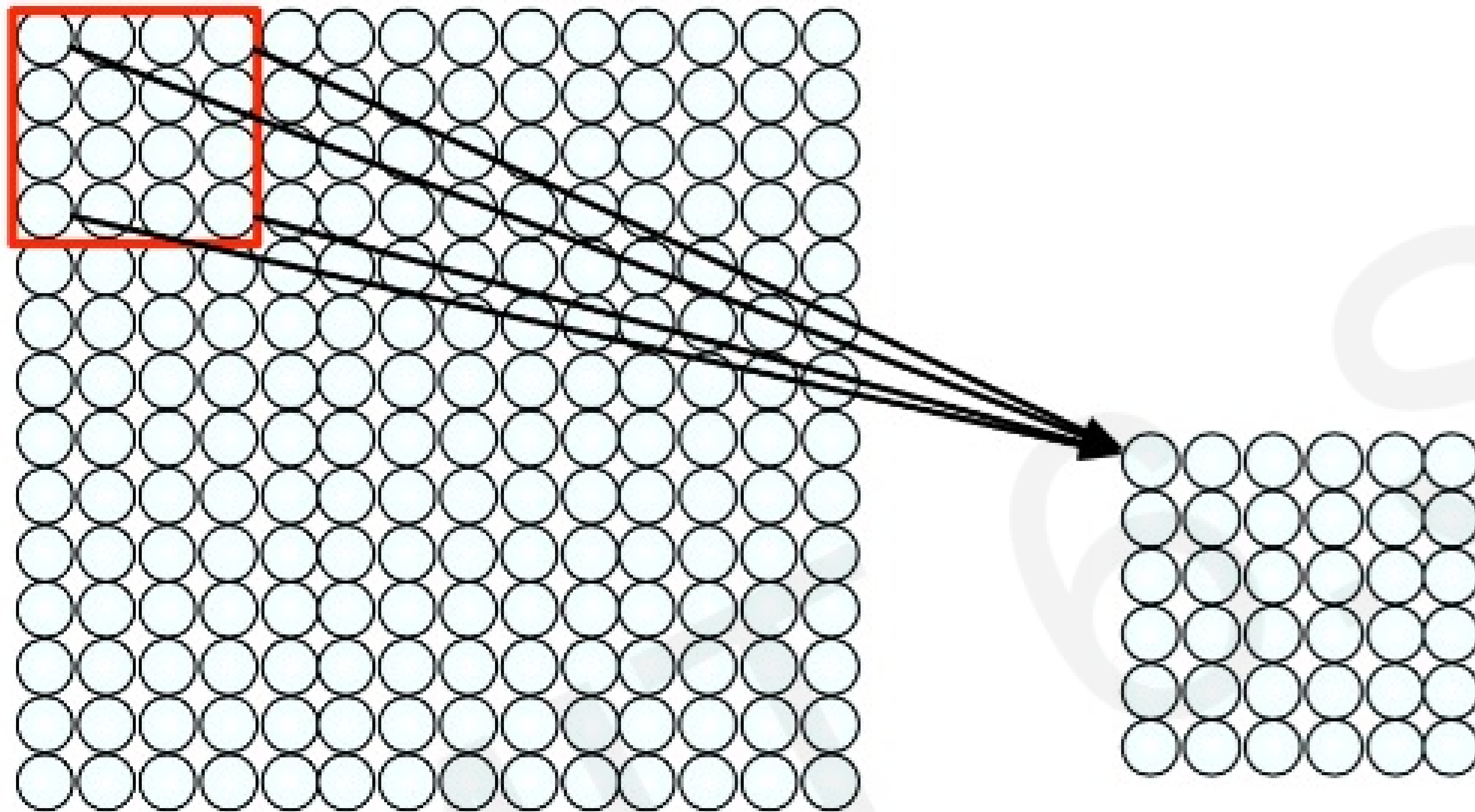

 `tf.keras.layers.Conv2D`

For a neuron in hidden layer:

- Take inputs from patch
- Compute weighted sum
- Apply bias

Convolutional Layers: Local Connectivity

 `tf.keras.layers.Conv2D`

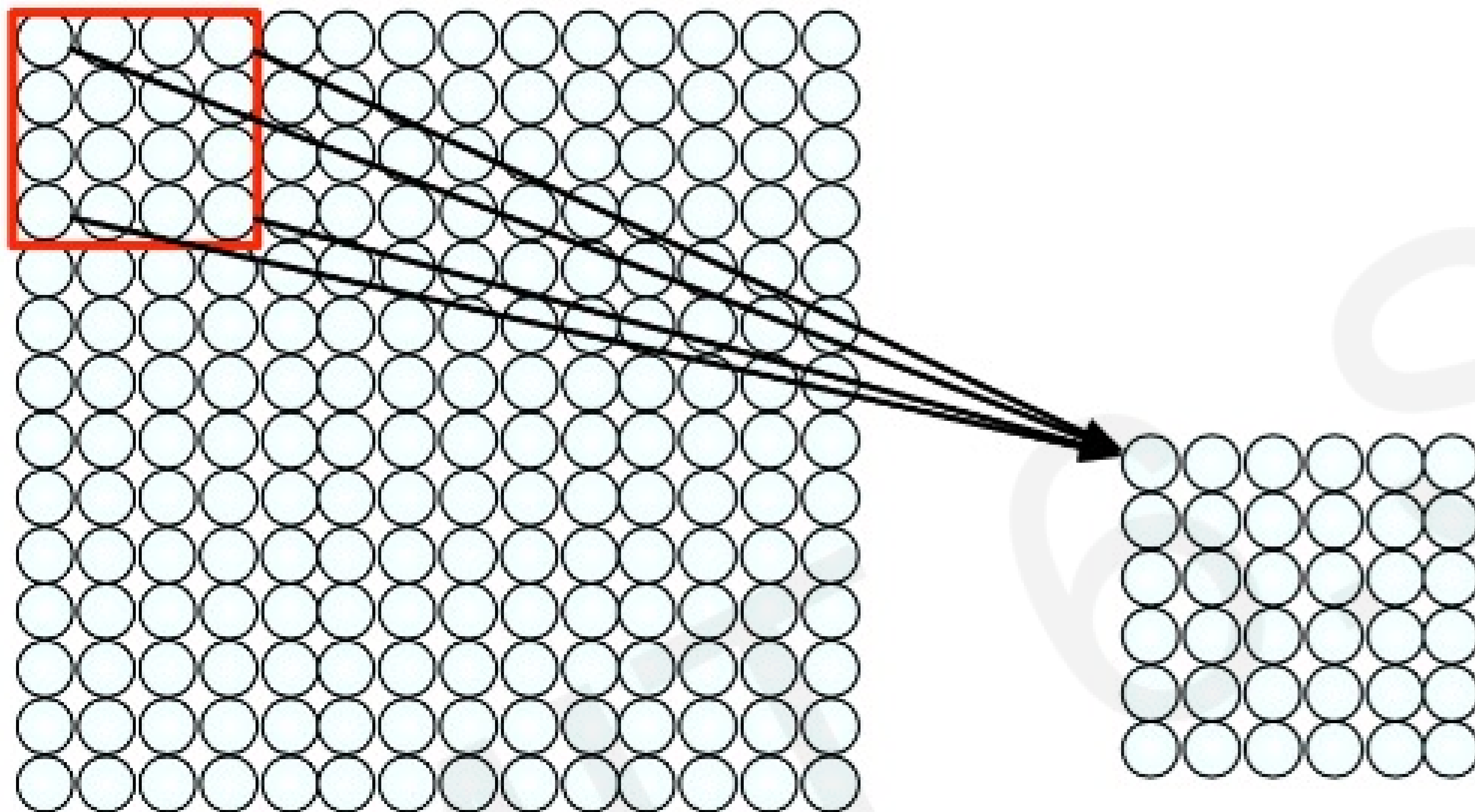

For a neuron in hidden layer:

- Take inputs from patch
- Compute weighted sum
- Apply bias

4x4 filter: matrix
of weights w_{ij}

$$\sum_{i=1}^4 \sum_{j=1}^4 w_{ij} x_{i+p,j+q} + b$$

for neuron (p,q) in hidden layer

- 1) applying a window of weights
- 2) computing linear combinations
- 3) activating with non-linear function

CNNs: Spatial Arrangement of Output Volume

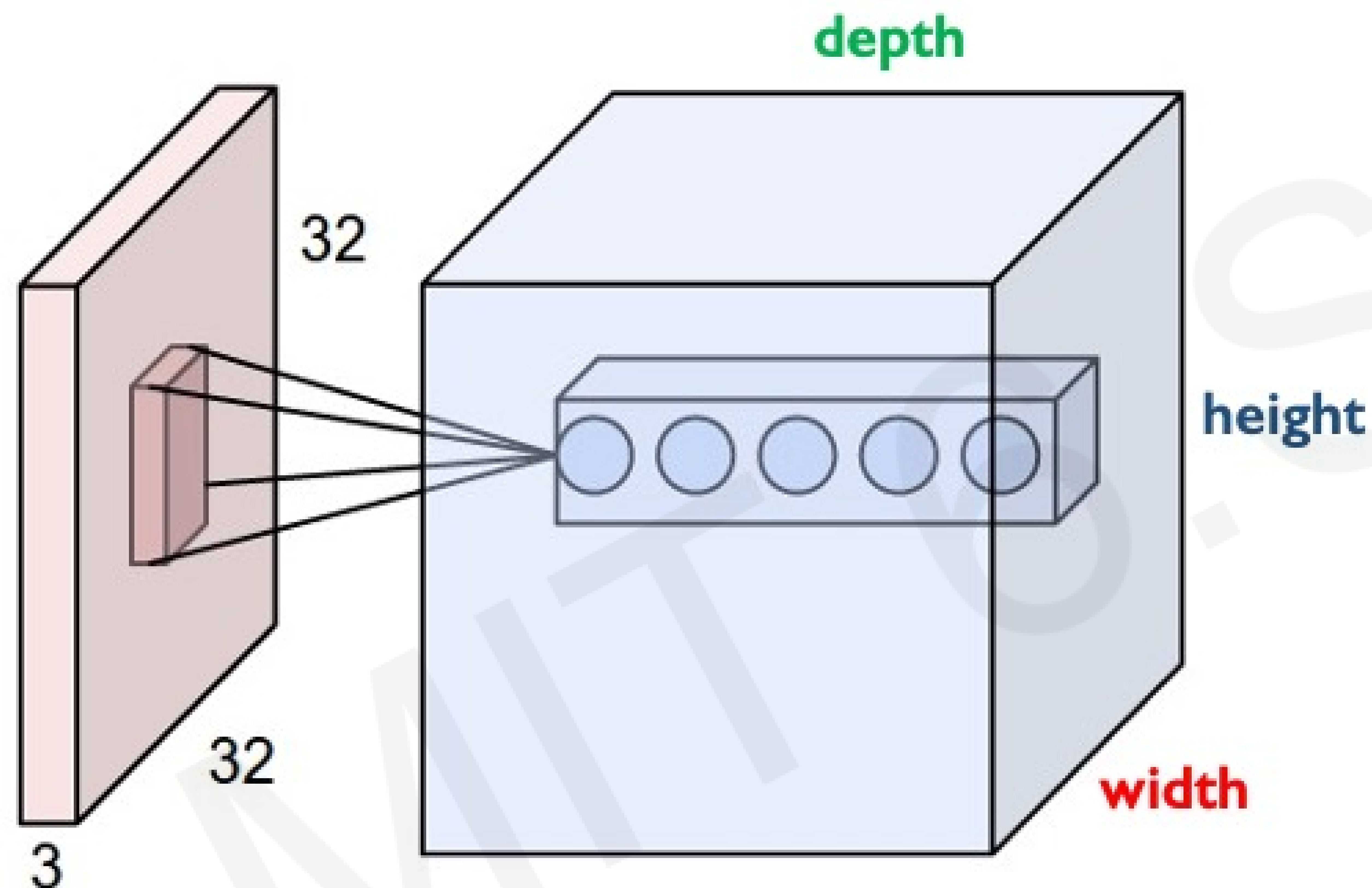

Layer Dimensions:

$$h \times w \times d$$

where h and w are spatial dimensions
 d (depth) = number of filters

Stride:

Filter step size

Receptive Field:

Locations in input image that
a node is path connected to



```
tf.keras.layers.Conv2D( filters=d, kernel_size=(h,w), strides=s )
```

Introducing Non-Linearity

- Apply after every convolution operation (i.e., after convolutional layers)
- ReLU: pixel-by-pixel operation that replaces all negative values by zero. **Non-linear operation!**

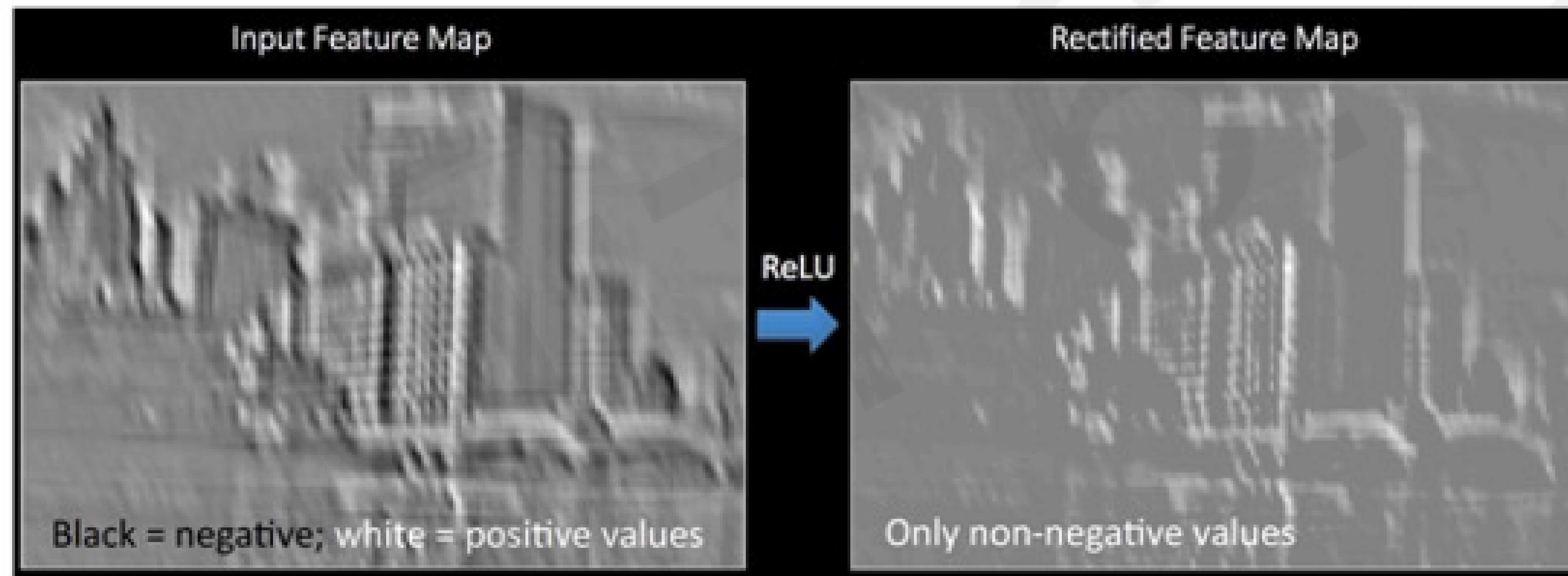

Rectified Linear Unit (ReLU)

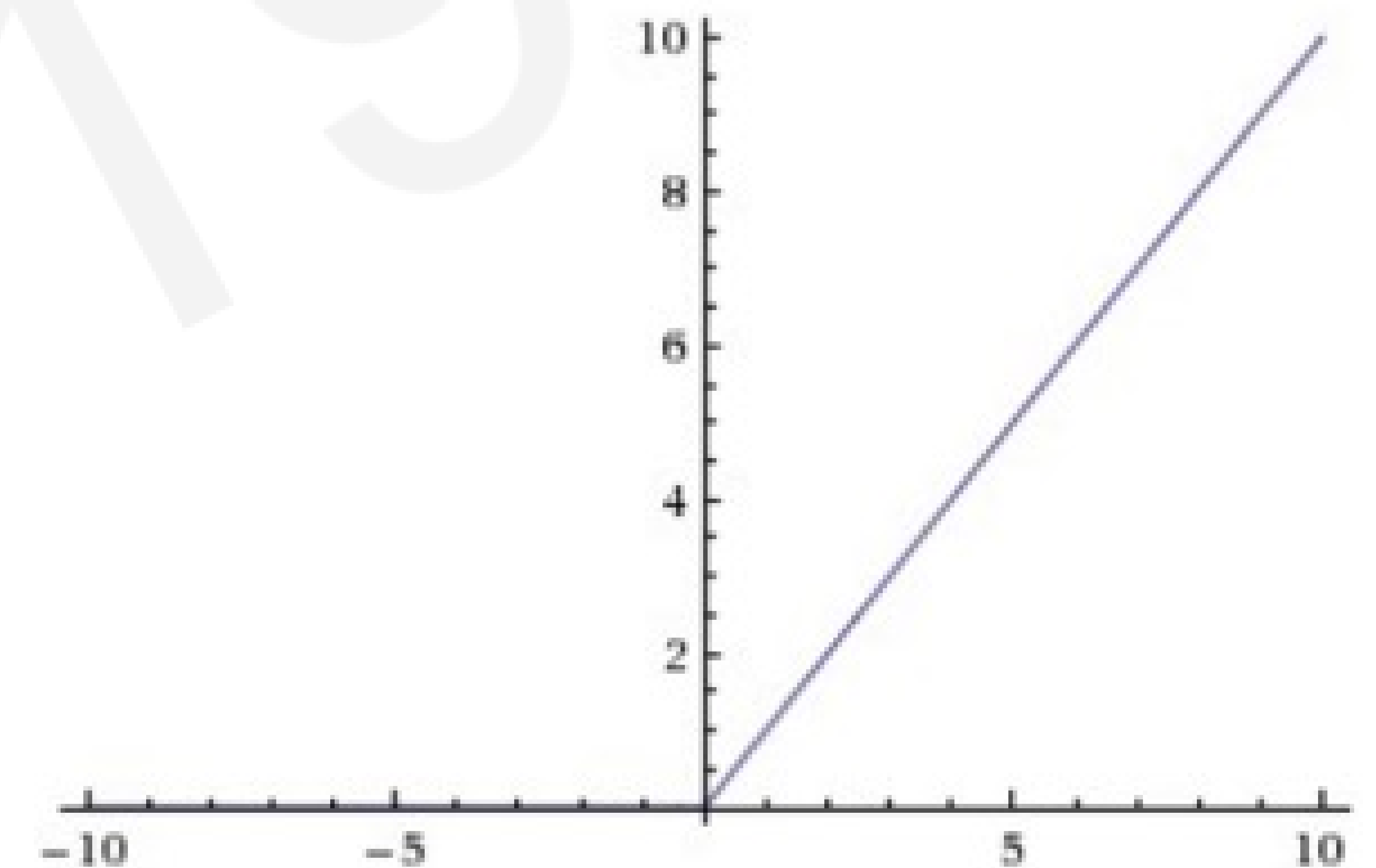

 `tf.keras.layers.ReLU`

Pooling

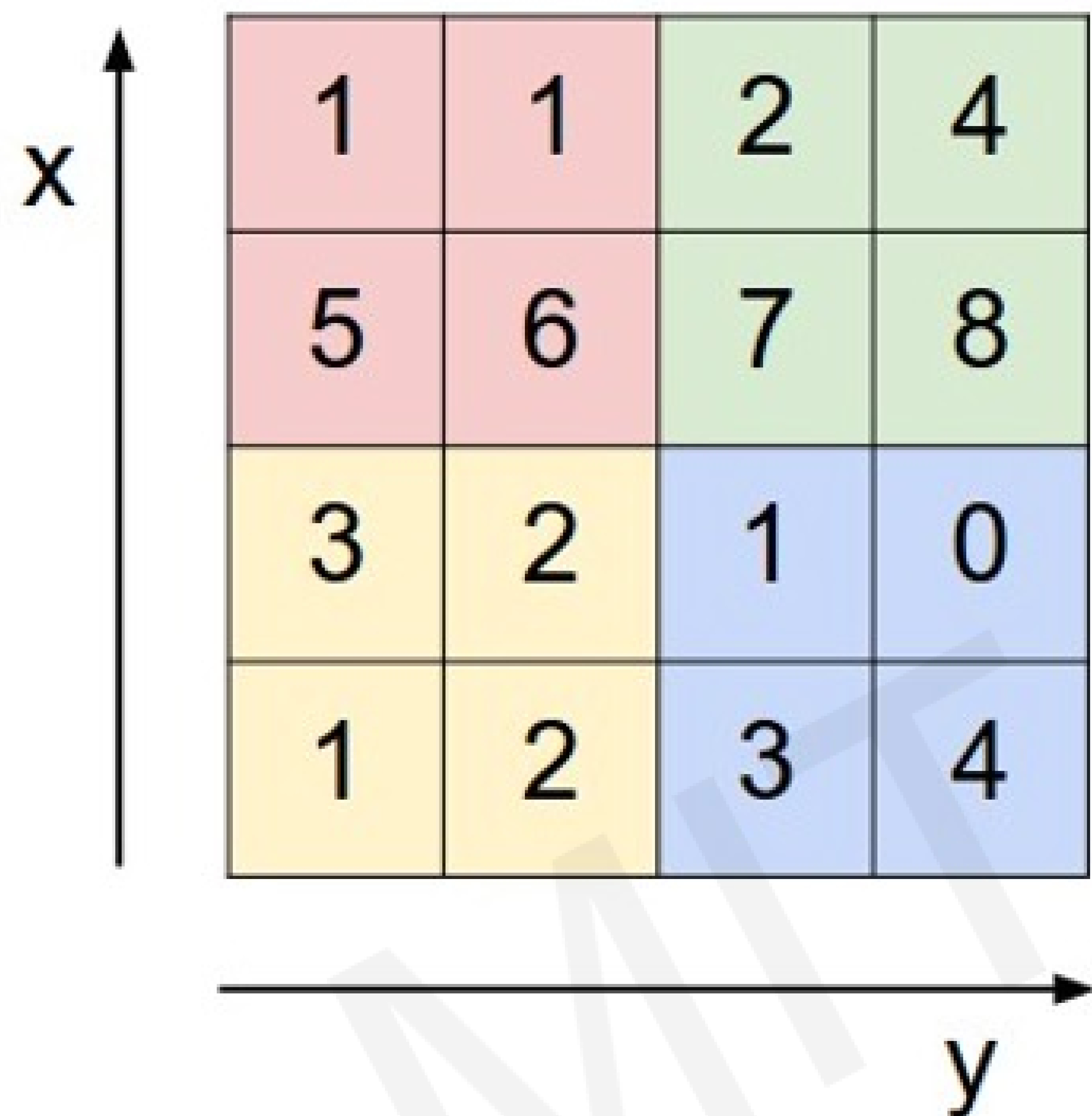

max pool with 2x2 filters
and stride 2

```
tf.keras.layers.MaxPool2D(  
    pool_size=(2,2),  
    strides=2  
)
```

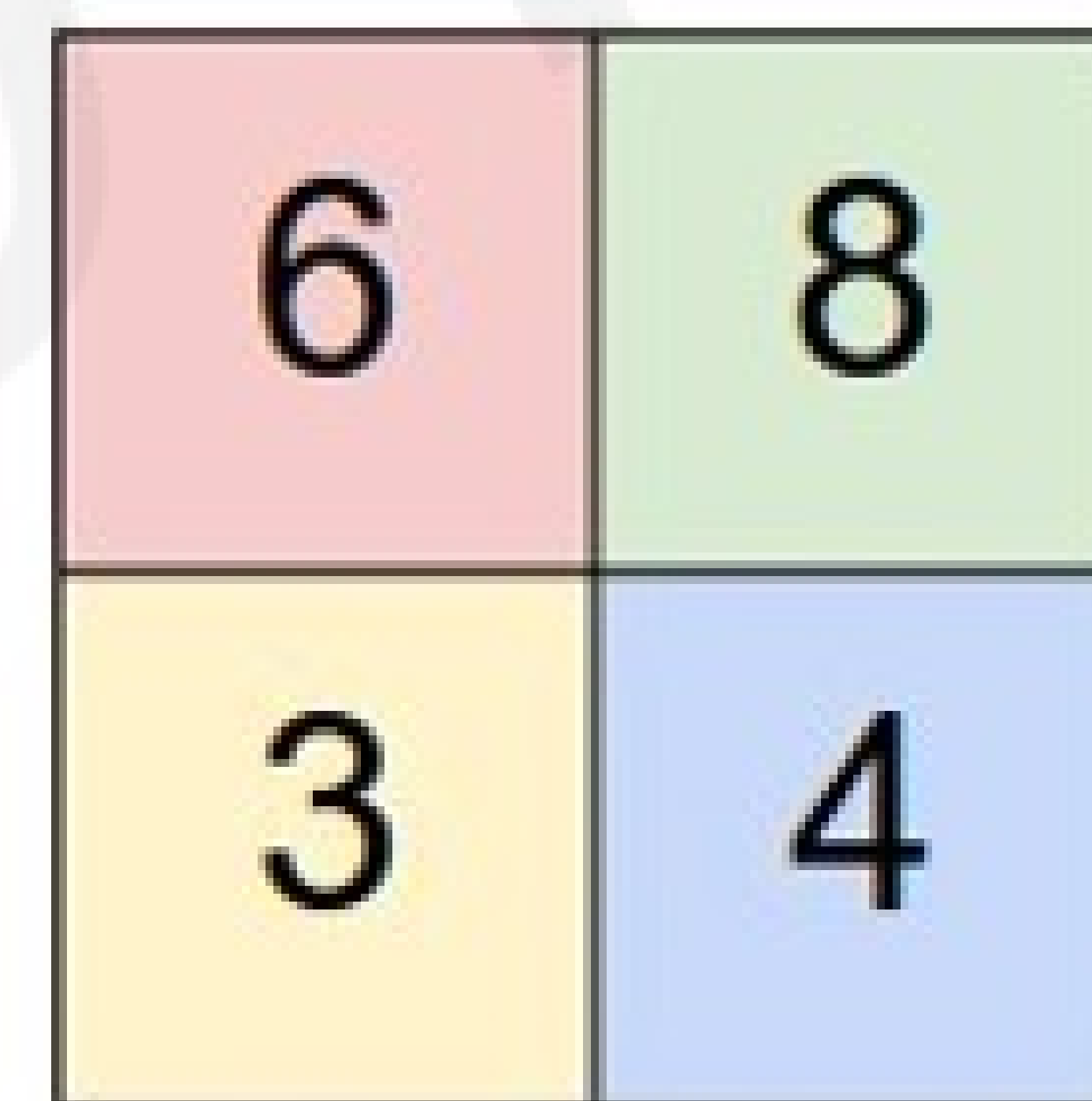

- 1) Reduced dimensionality
- 2) Spatial invariance

How else can we downsample and preserve spatial invariance?

Representation Learning in Deep CNNs

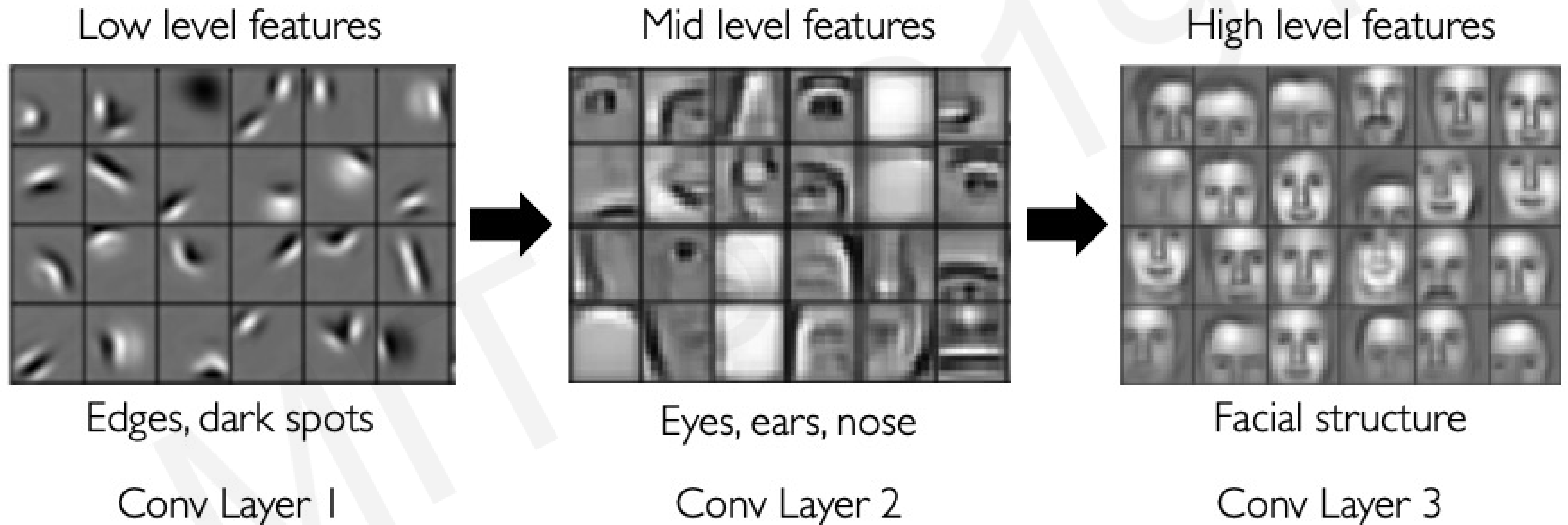

CNNs for Classification: Feature Learning

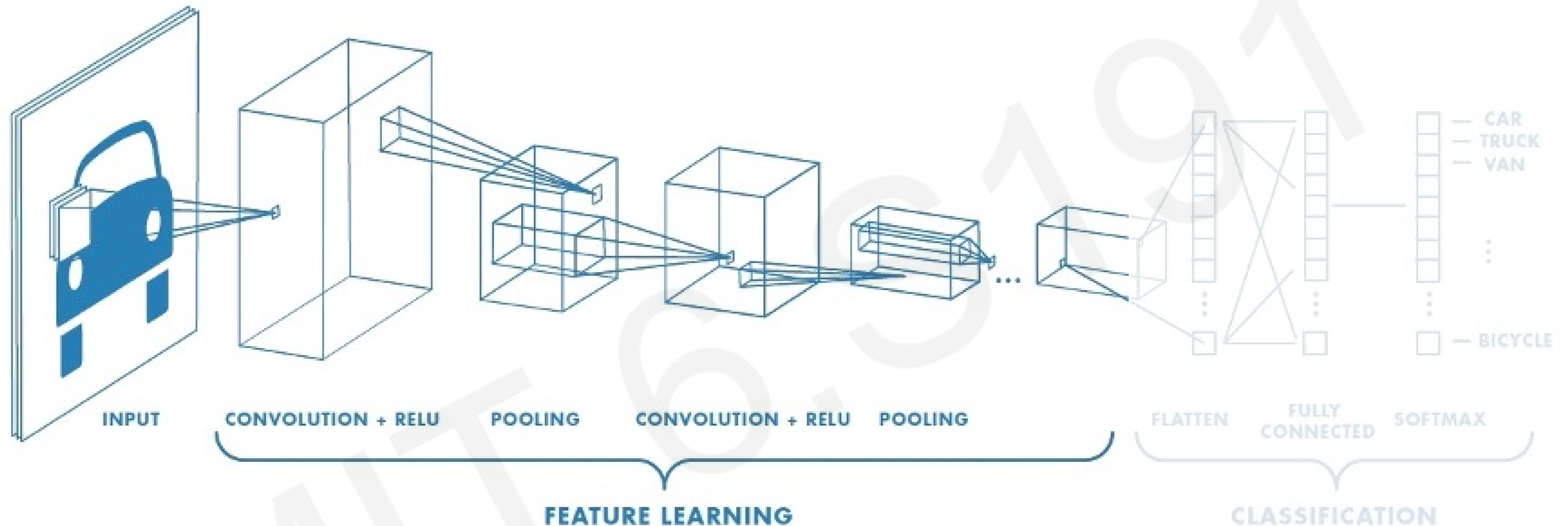

1. Learn features in input image through **convolution**
2. Introduce **non-linearity** through activation function (real-world data is non-linear!)
3. Reduce dimensionality and preserve spatial invariance with **pooling**

CNNs for Classification: Class Probabilities

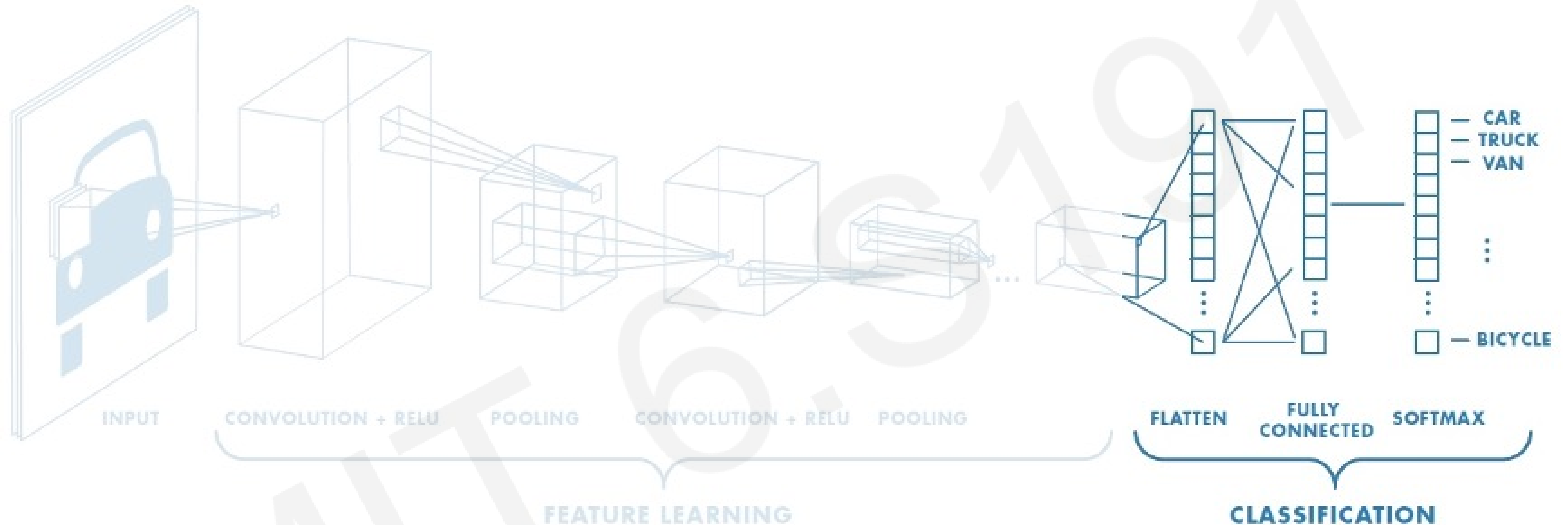

- CONV and POOL layers output high-level features of input
- Fully connected layer uses these features for classifying input image
- Express output as **probability** of image belonging to a particular class

$$\text{softmax}(y_i) = \frac{e^{y_i}}{\sum_j e^{y_j}}$$

Putting it all together

```
import tensorflow as tf

def generate_model():
    model = tf.keras.Sequential([
        # first convolutional layer
        tf.keras.layers.Conv2D(32, filter_size=3, activation='relu'),
        tf.keras.layers.MaxPool2D(pool_size=2, strides=2),

        # second convolutional layer
        tf.keras.layers.Conv2D(64, filter_size=3, activation='relu'),
        tf.keras.layers.MaxPool2D(pool_size=2, strides=2),

        # fully connected classifier
        tf.keras.layers.Flatten(),
        tf.keras.layers.Dense(1024, activation='relu'),
        tf.keras.layers.Dense(10, activation='softmax') # 10 outputs
    ])
    return model
```

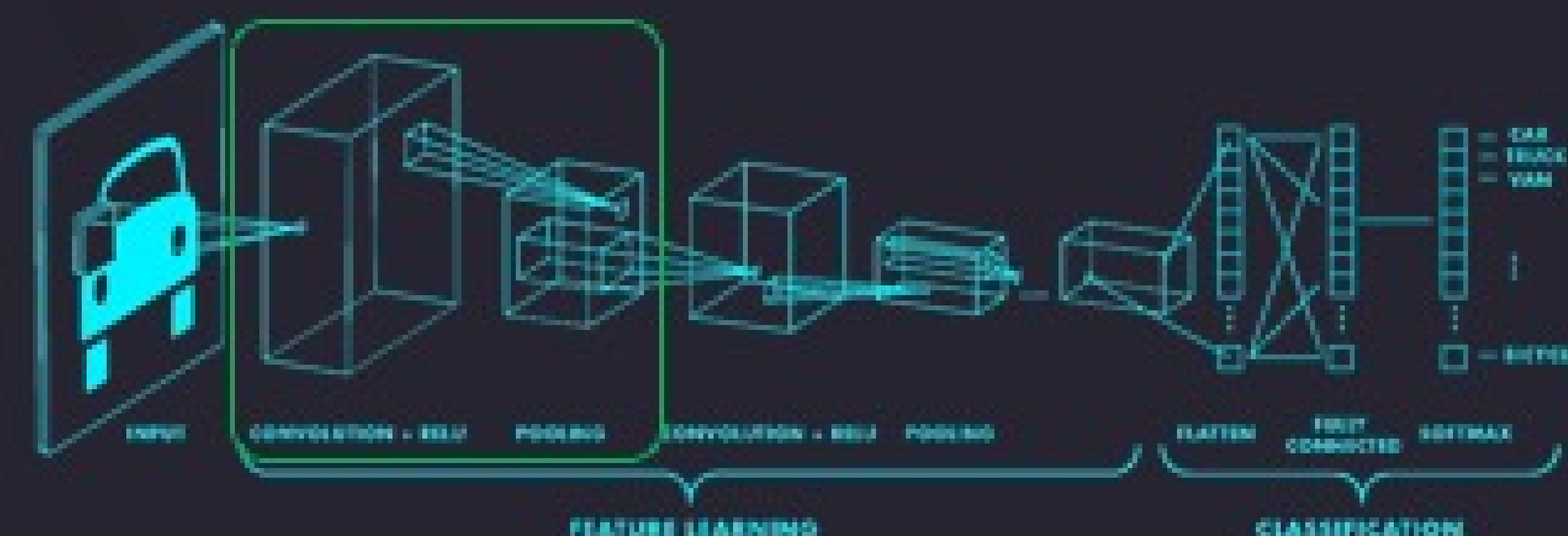

An Architecture for Many Applications

An Architecture for Many Applications

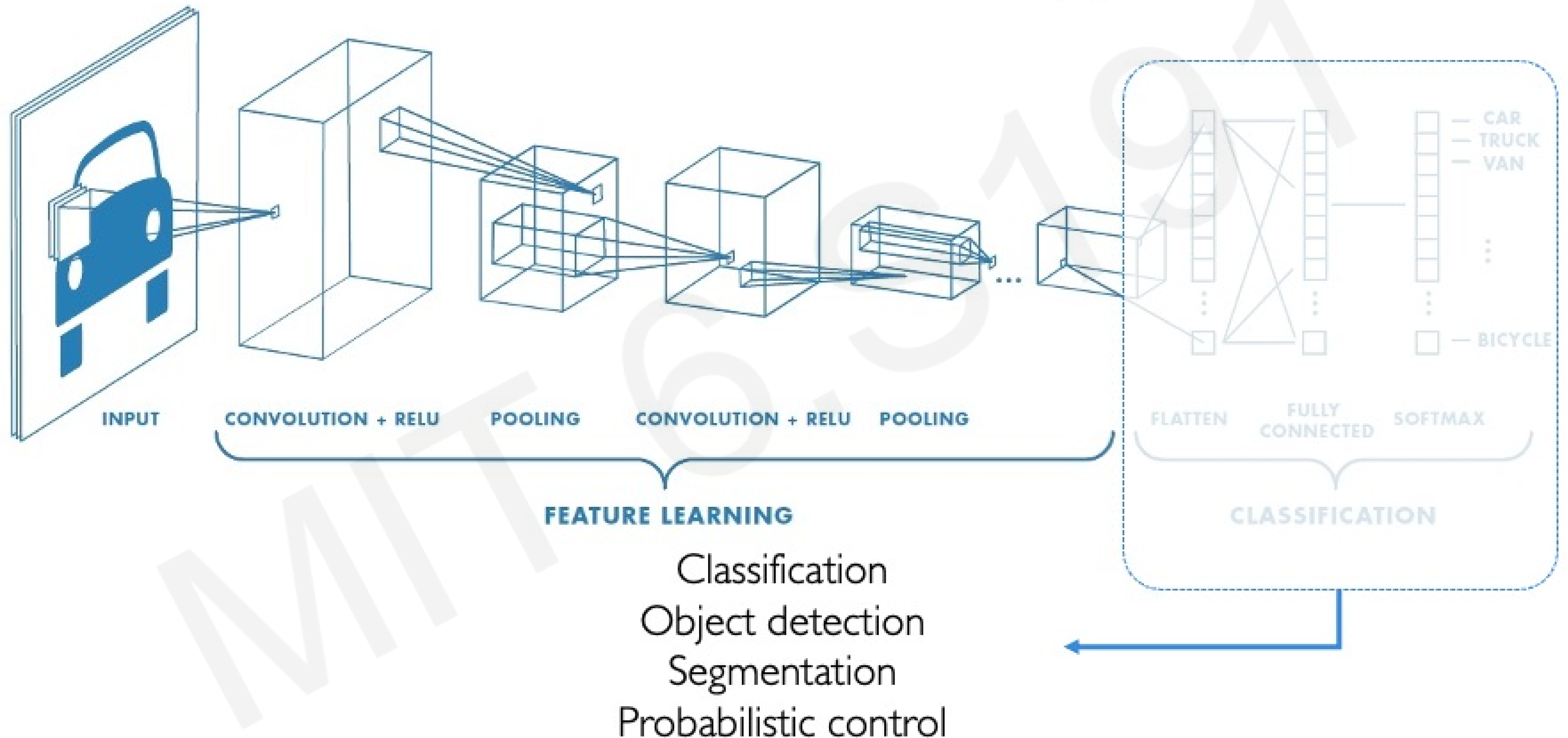

Classification: Breast Cancer Screening

International evaluation of an AI system for breast cancer screening nature

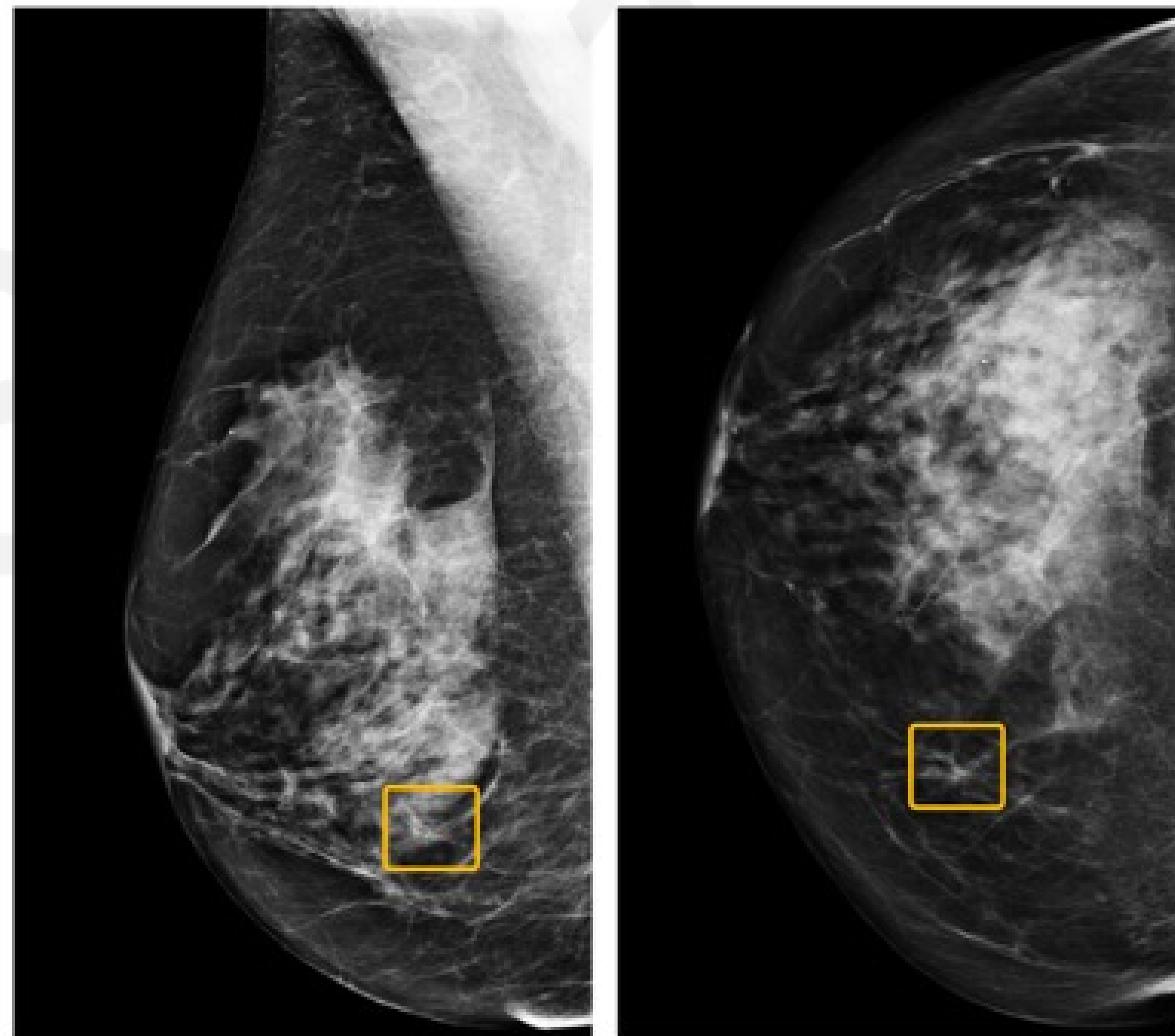
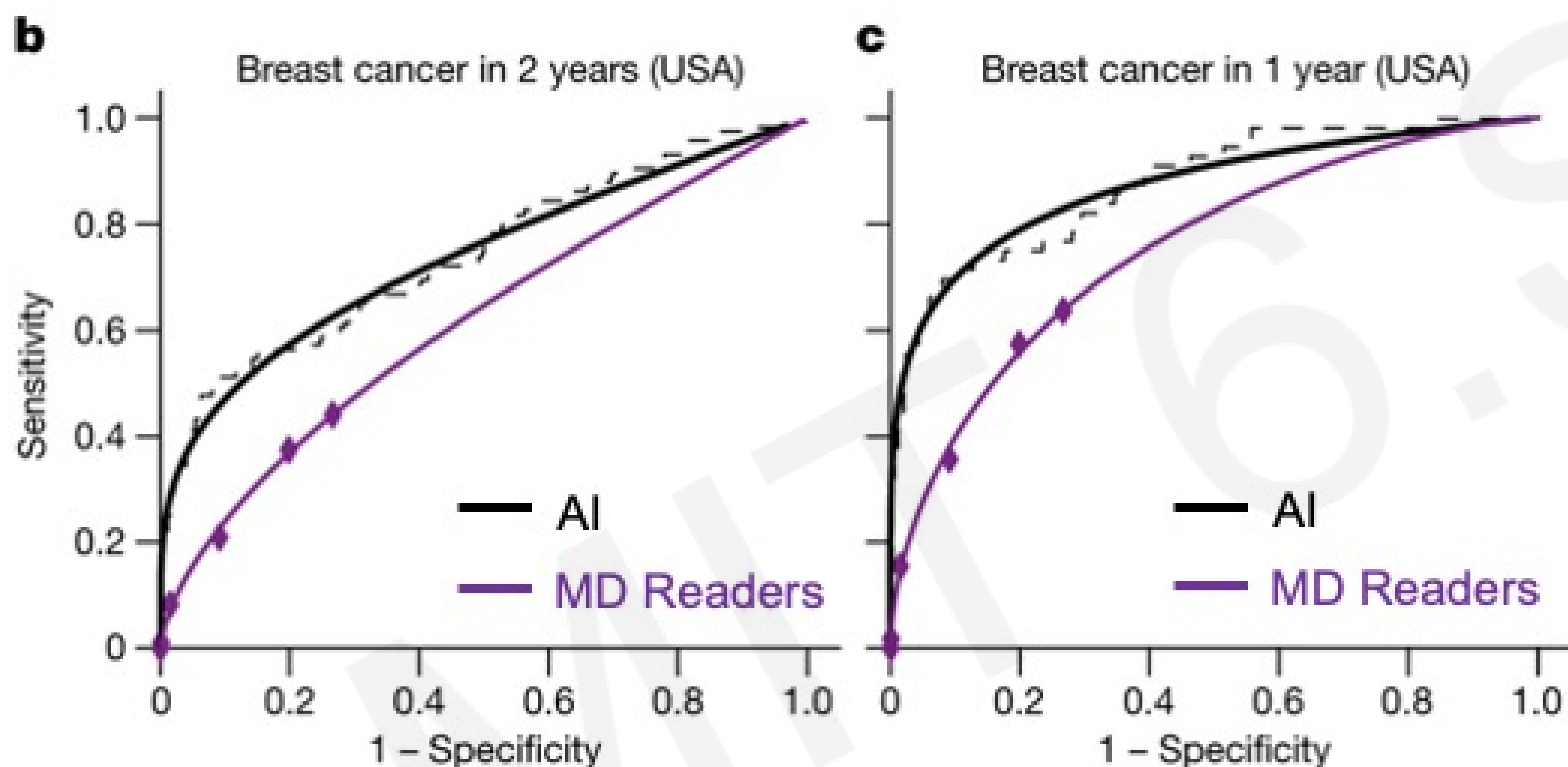

CNN-based system outperformed expert radiologists at detecting breast cancer from mammograms

Breast cancer case missed by radiologist but detected by AI

Object Detection



Image X

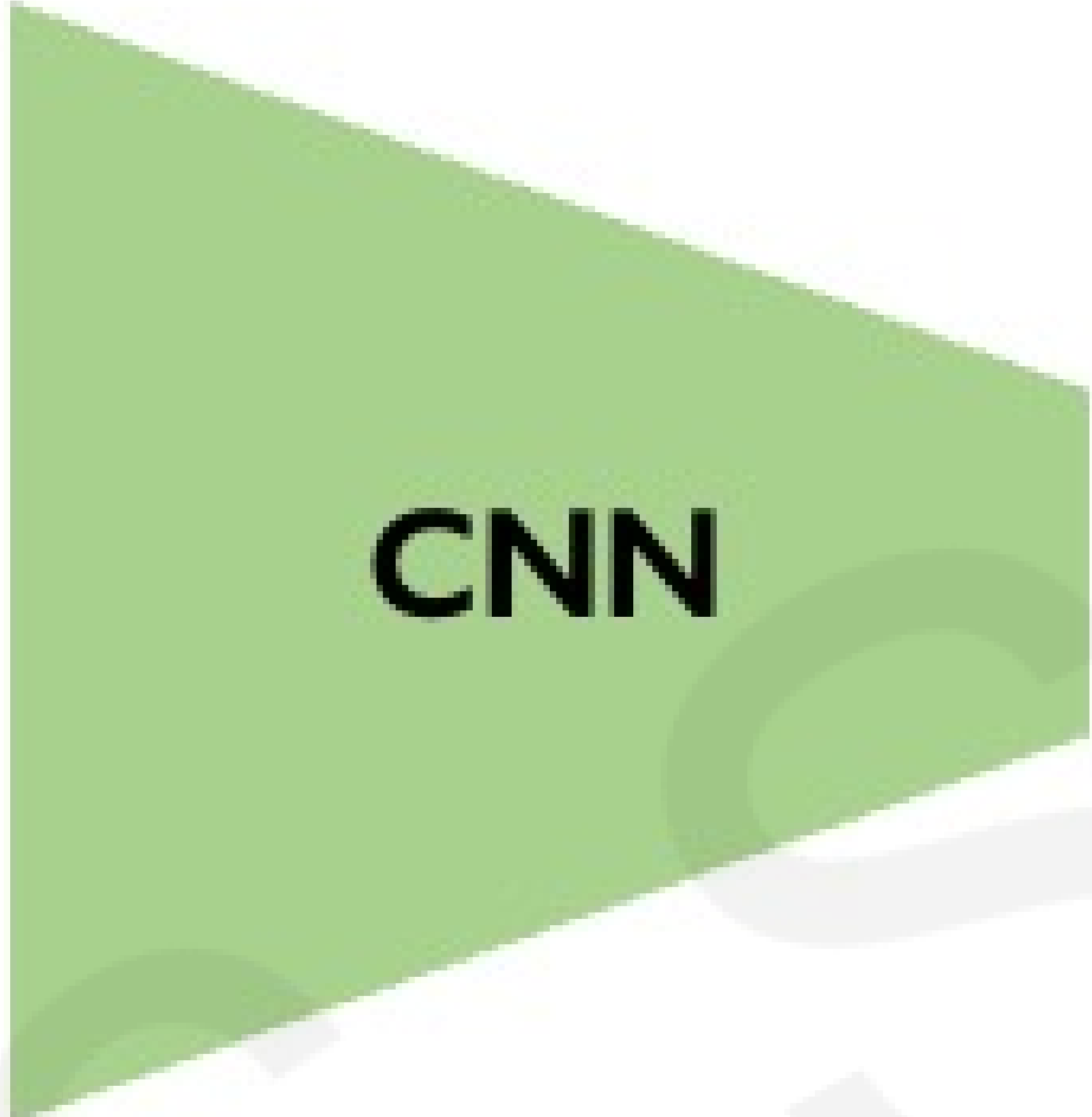
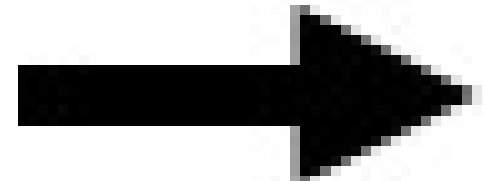

CNN

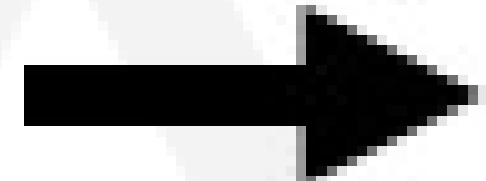

Taxi

Class label y

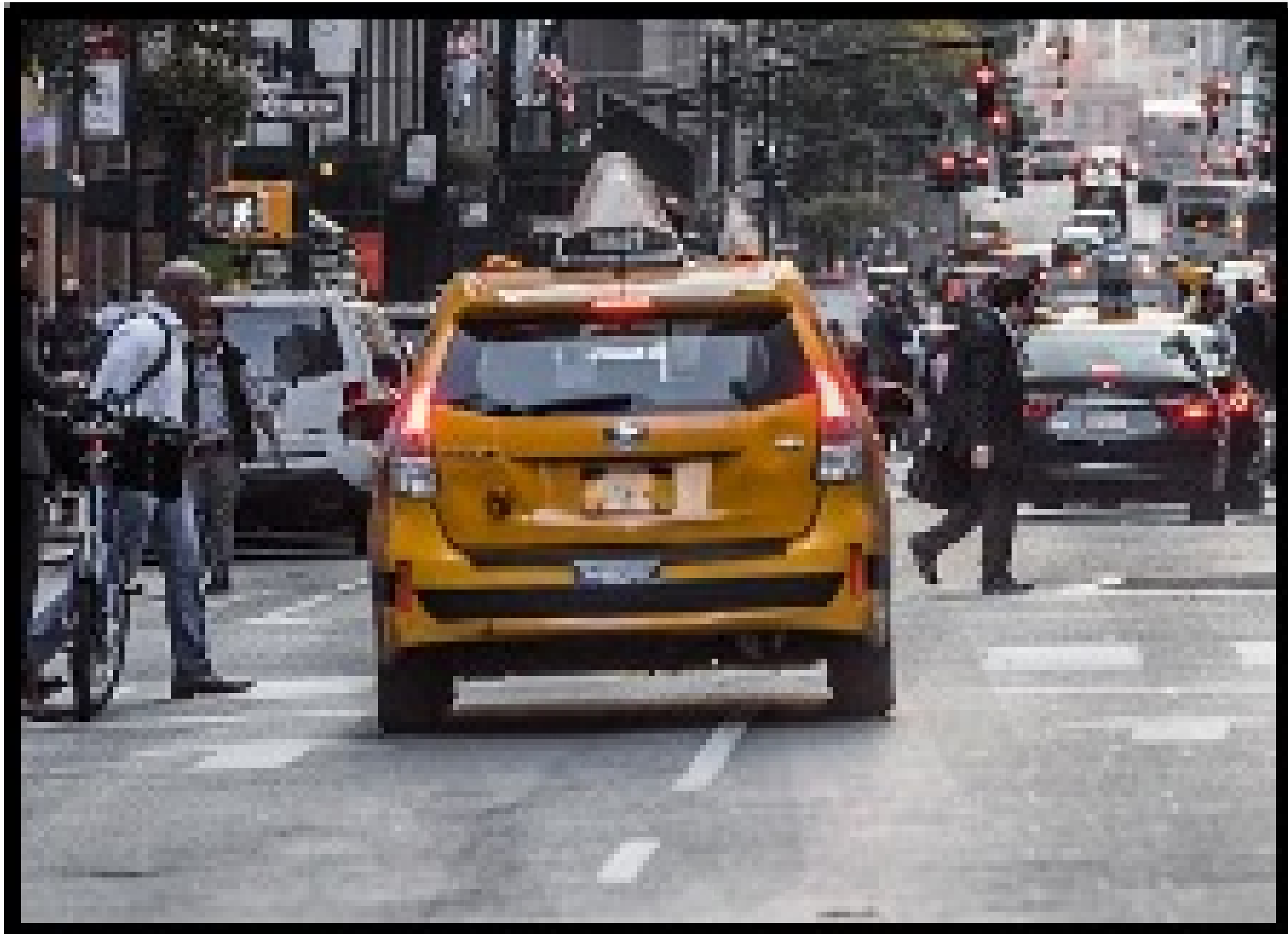
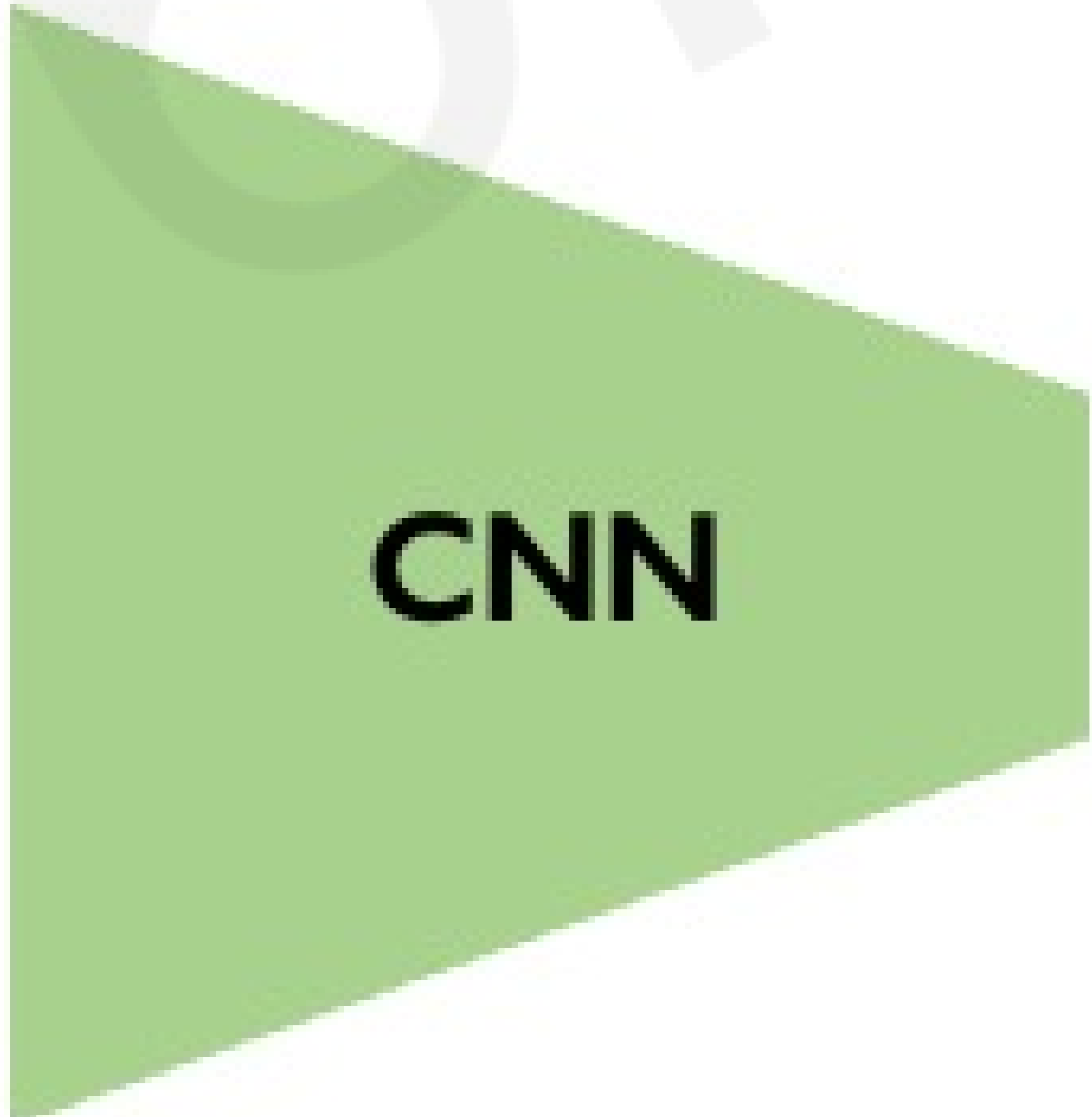
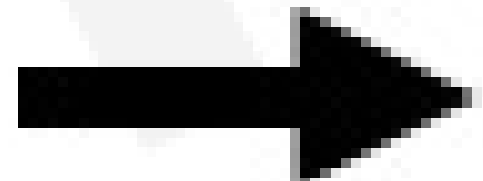
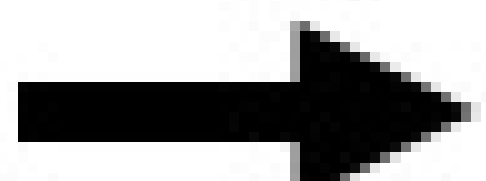

Image X



CNN



Label (x, y, w, h)

Object Detection



Image X

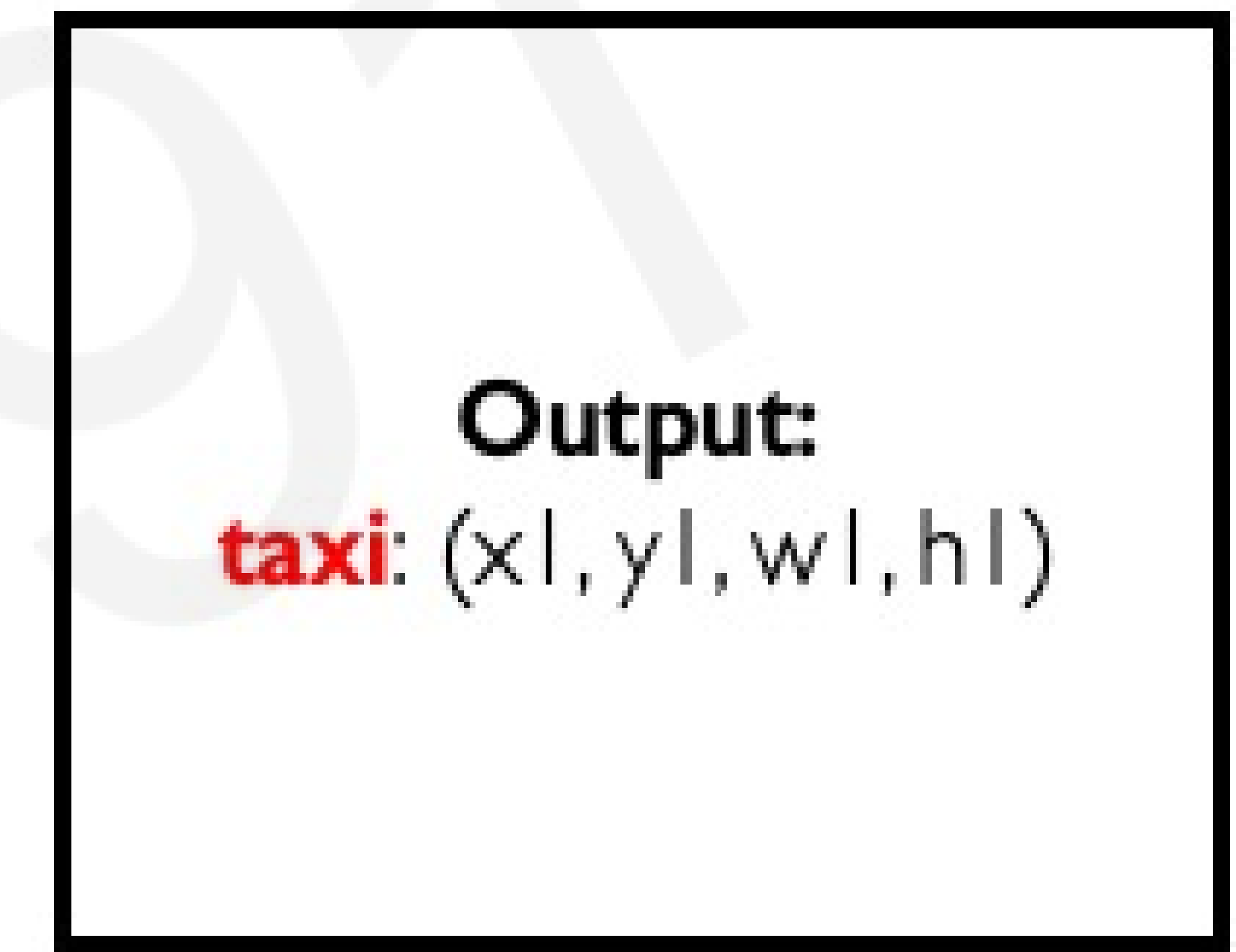
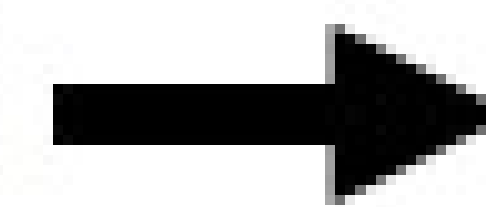
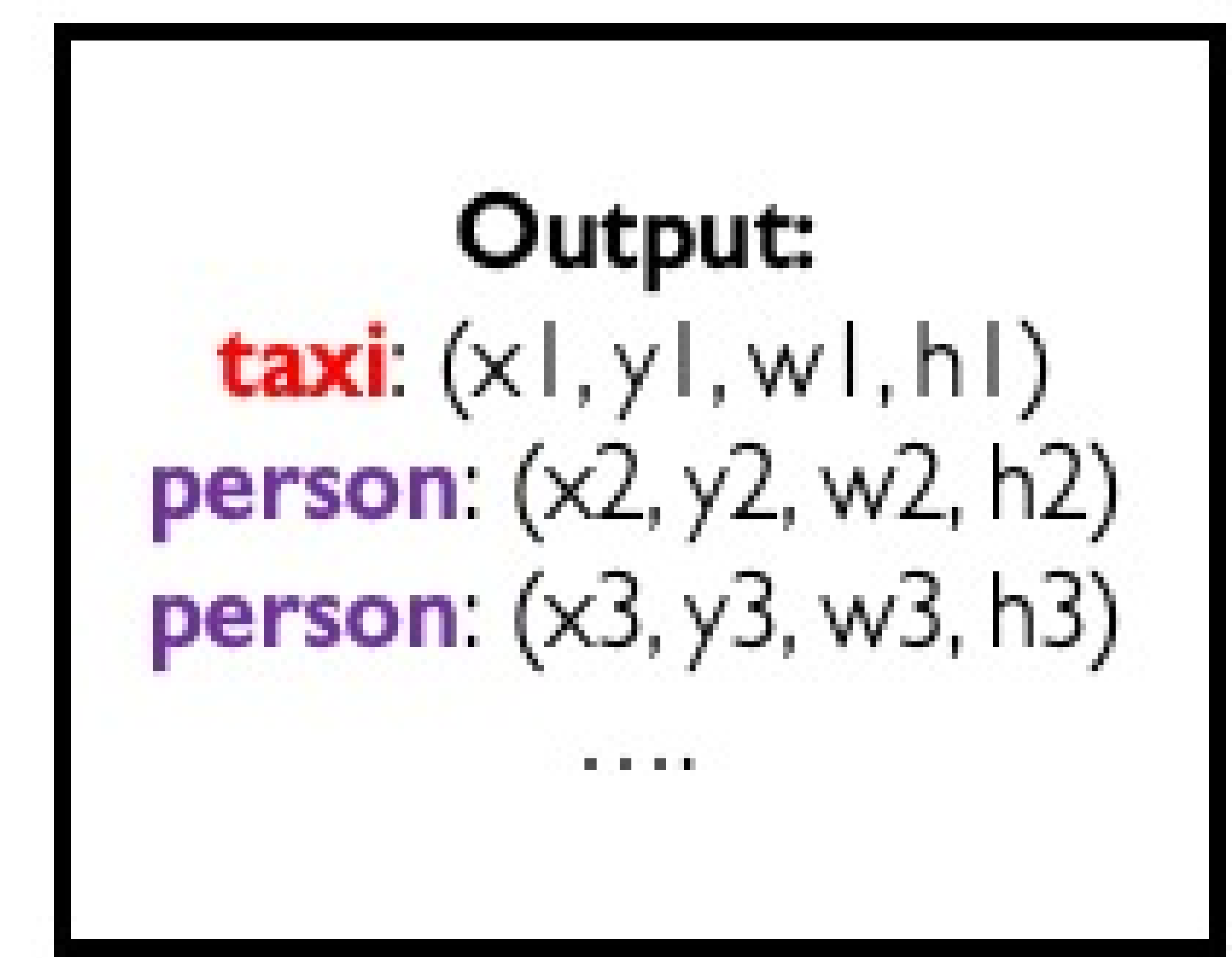
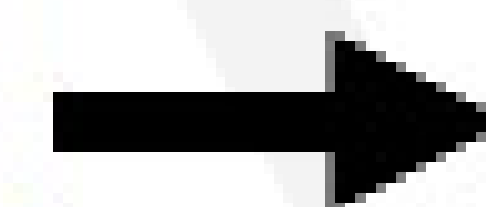
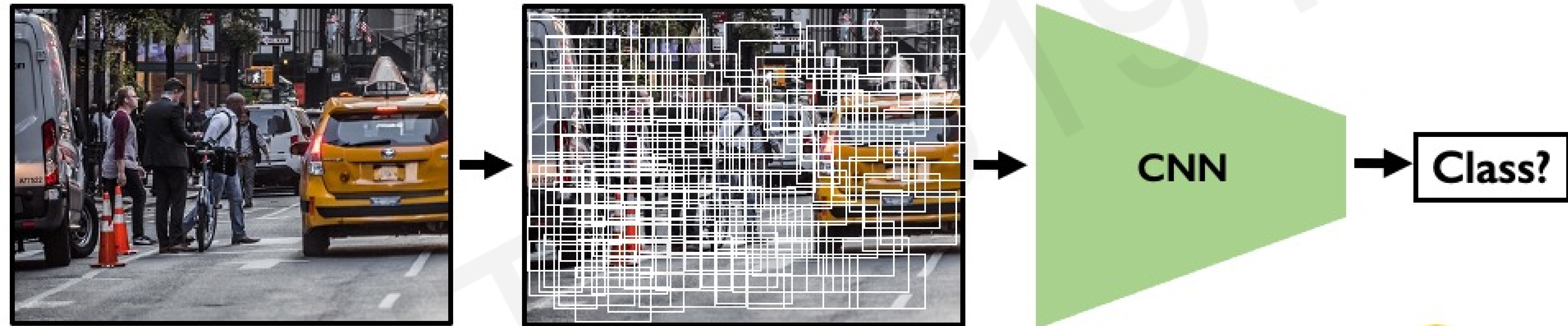

Image X



Naïve Solution to Object Detection



Problem: Way too many inputs! This results in too many scales, positions, sizes!

Object Detection with R-CNNs

R-CNN algorithm: Find regions that we think have objects. Use CNN to classify.

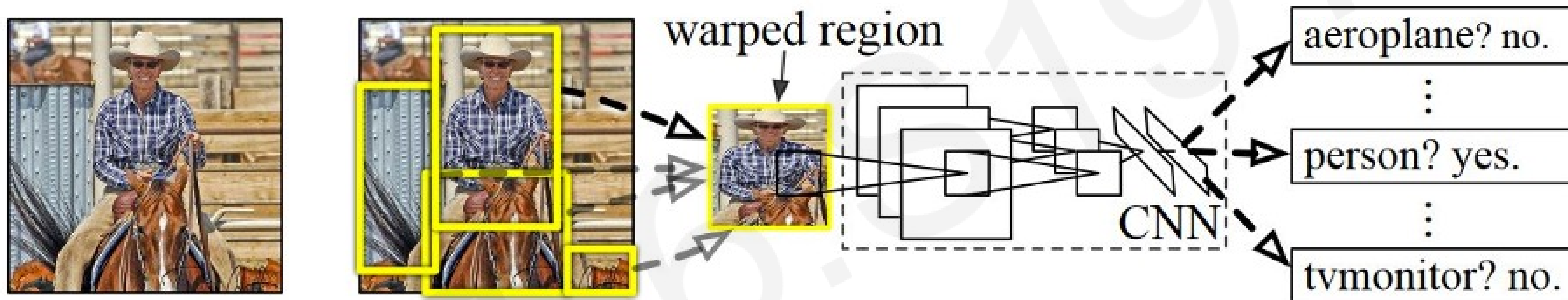

1. Input image

2. Extract region proposals (~2k)

3. Compute CNN features

4. Classify regions

Problems: 1) Slow! Many regions; time intensive inference.
2) Brittle! Manually defined region proposals.

Faster R-CNN Learns Region Proposals

Classification of regions →
object detection

Feature extraction over
proposed regions

Region proposal network
to learn candidate regions
Learned, data-driven

Image input directly into
convolutional feature extractor
Fast! Only input image once!

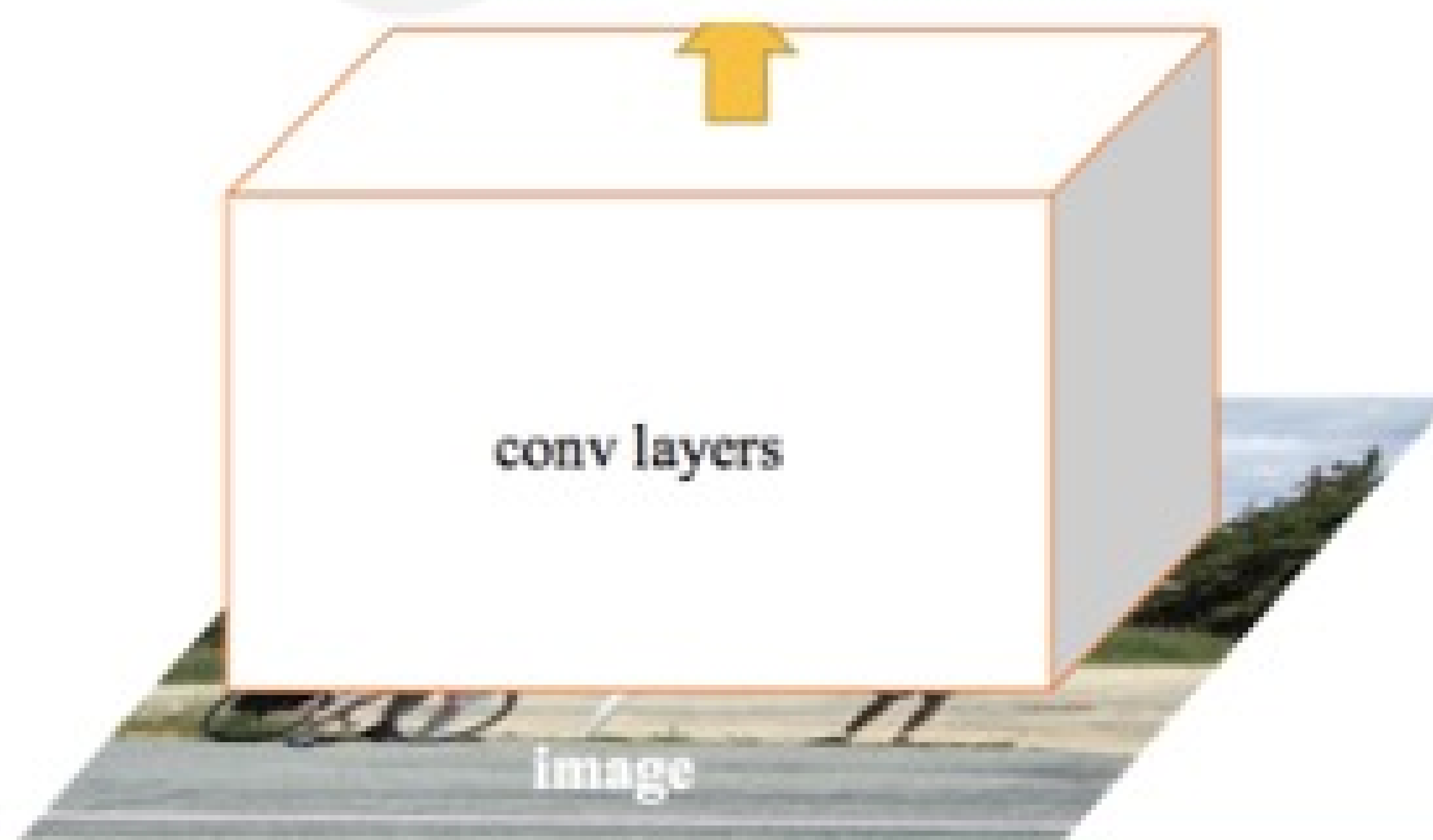

Semantic Segmentation: Fully Convolutional Networks

FCN: Fully Convolutional Network.
Network designed with all convolutional layers,
with **downsampling** and **upsampling** operations



Input:
 $3 \times H \times W$

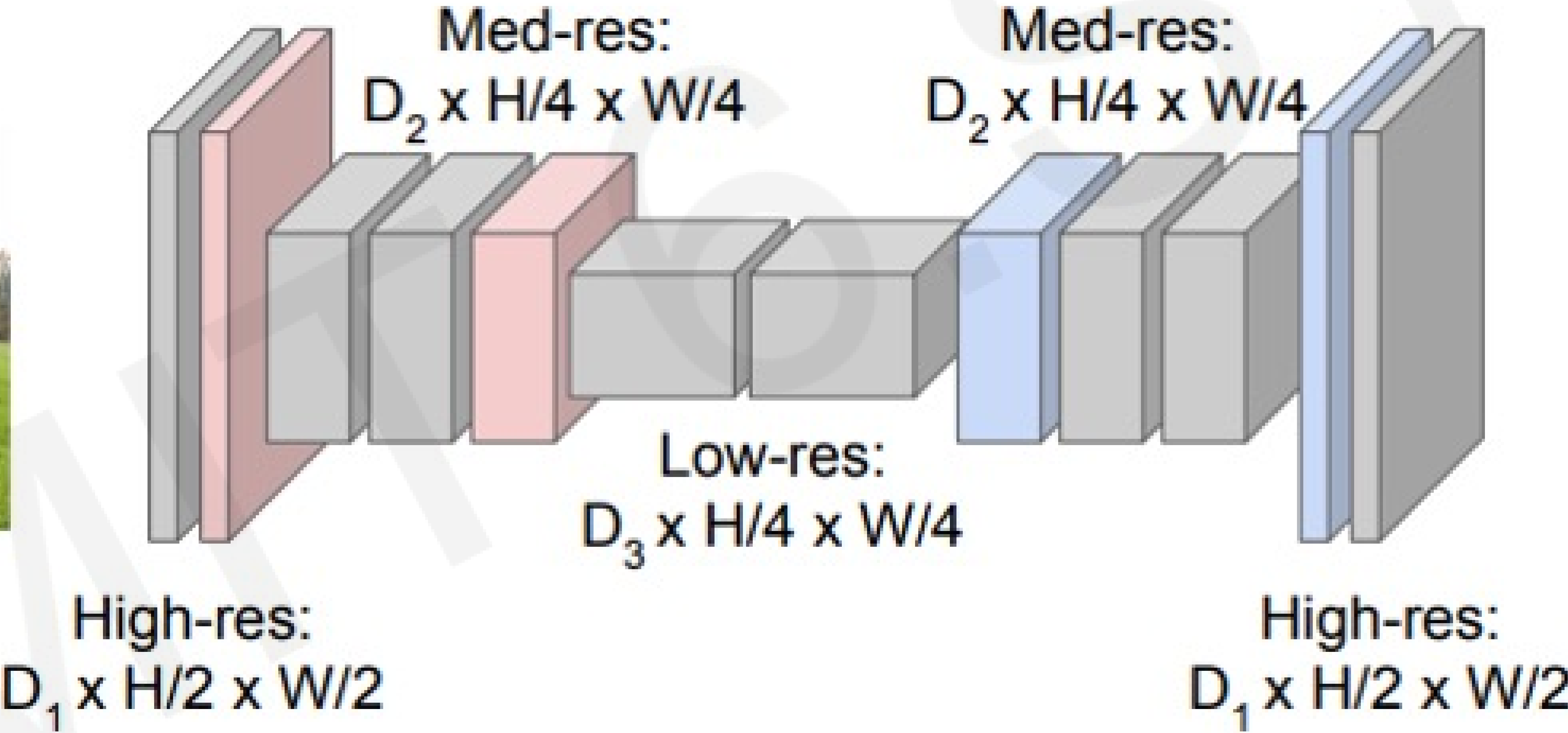

Predictions:
 $H \times W$

```
tf.keras.layers.Conv2DTranspose
```

Semantic Segmentation: Biomedical Image Analysis

Brain Tumors
Dong+ *MIUA* 2017.

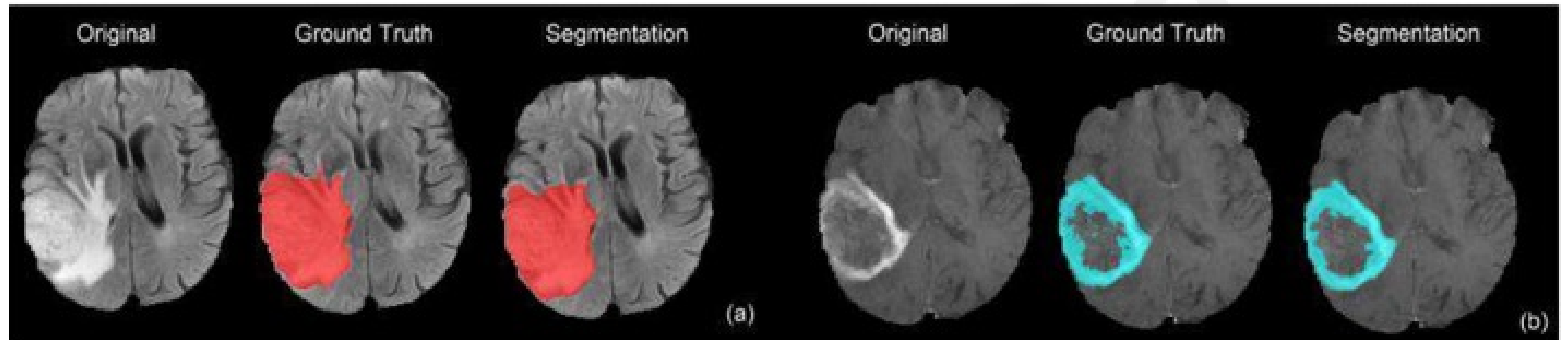

Malaria Infection
Soleimany+ *arXiv* 2019.

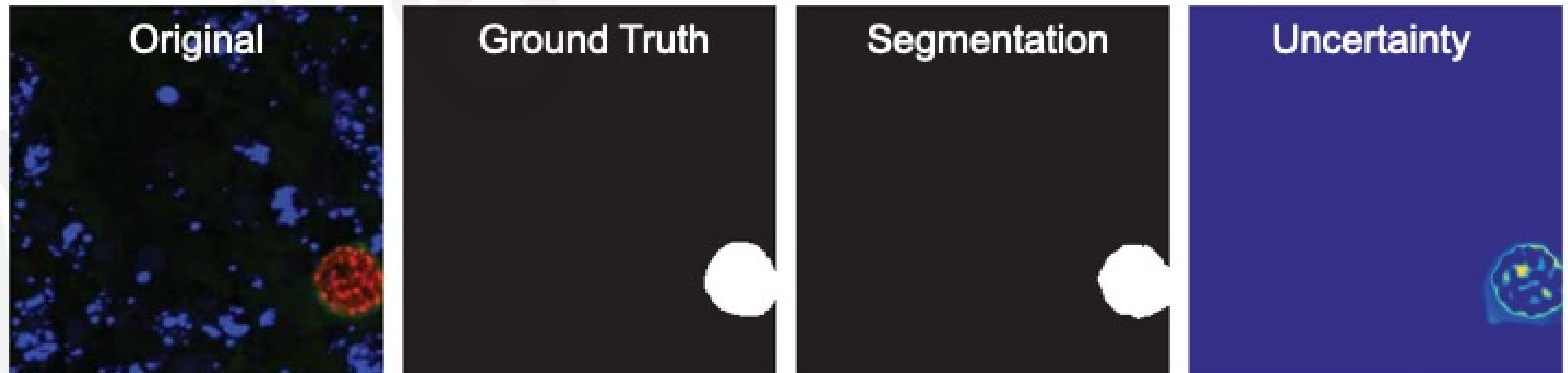

Continuous Control: Navigation from Vision

Raw Perception
 I
(ex. camera)



Coarse Maps
 M
(ex. GPS)

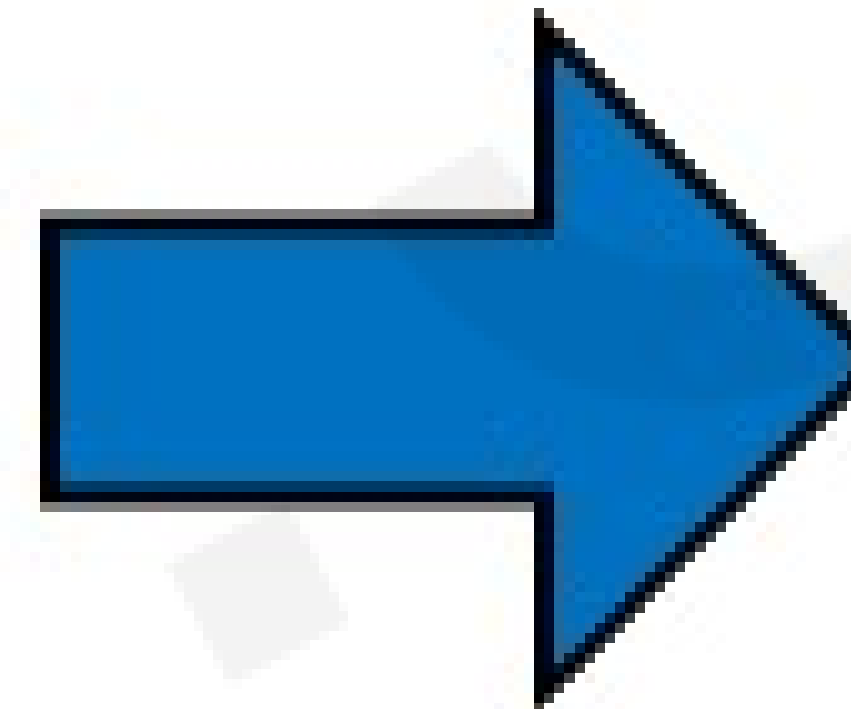
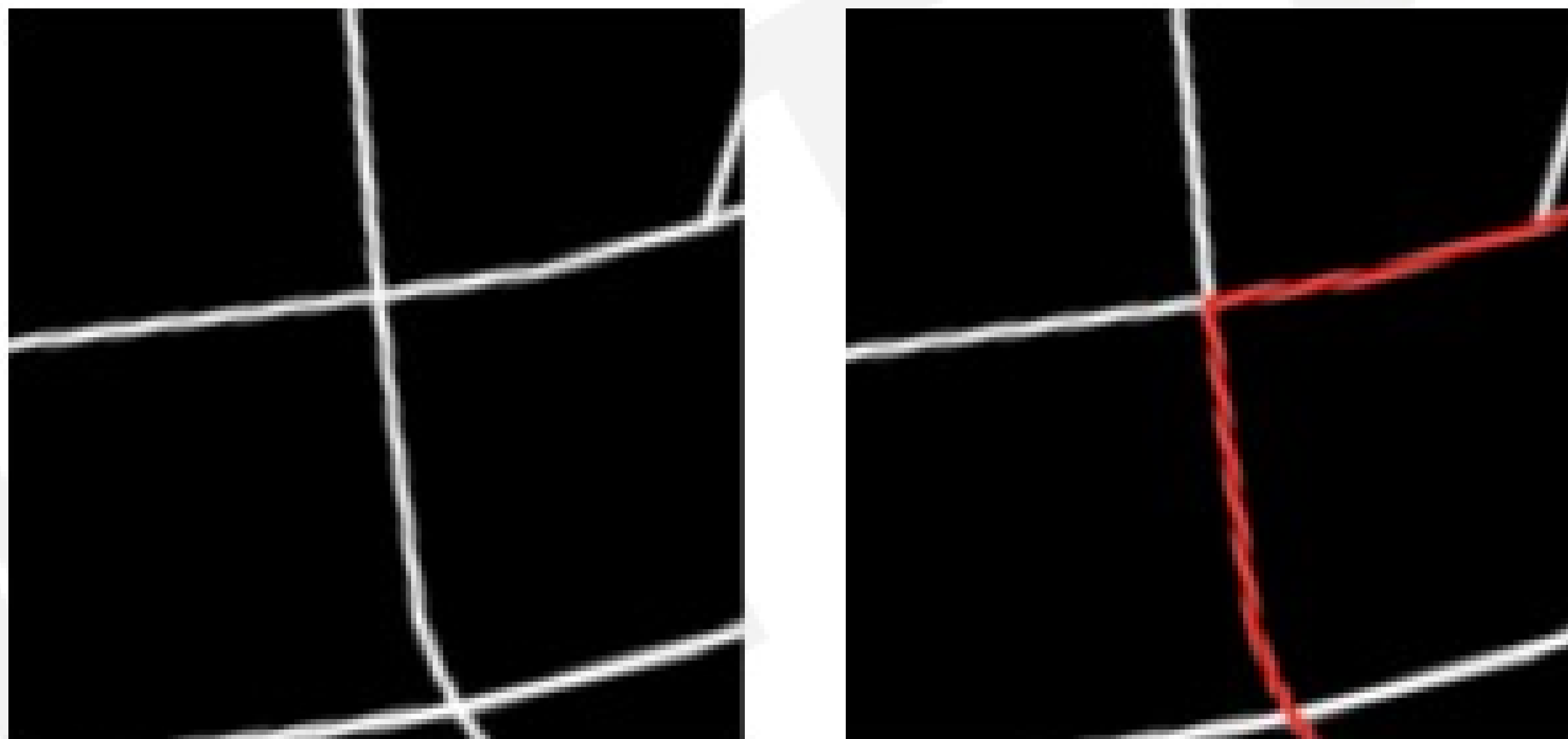

Possible Control Commands

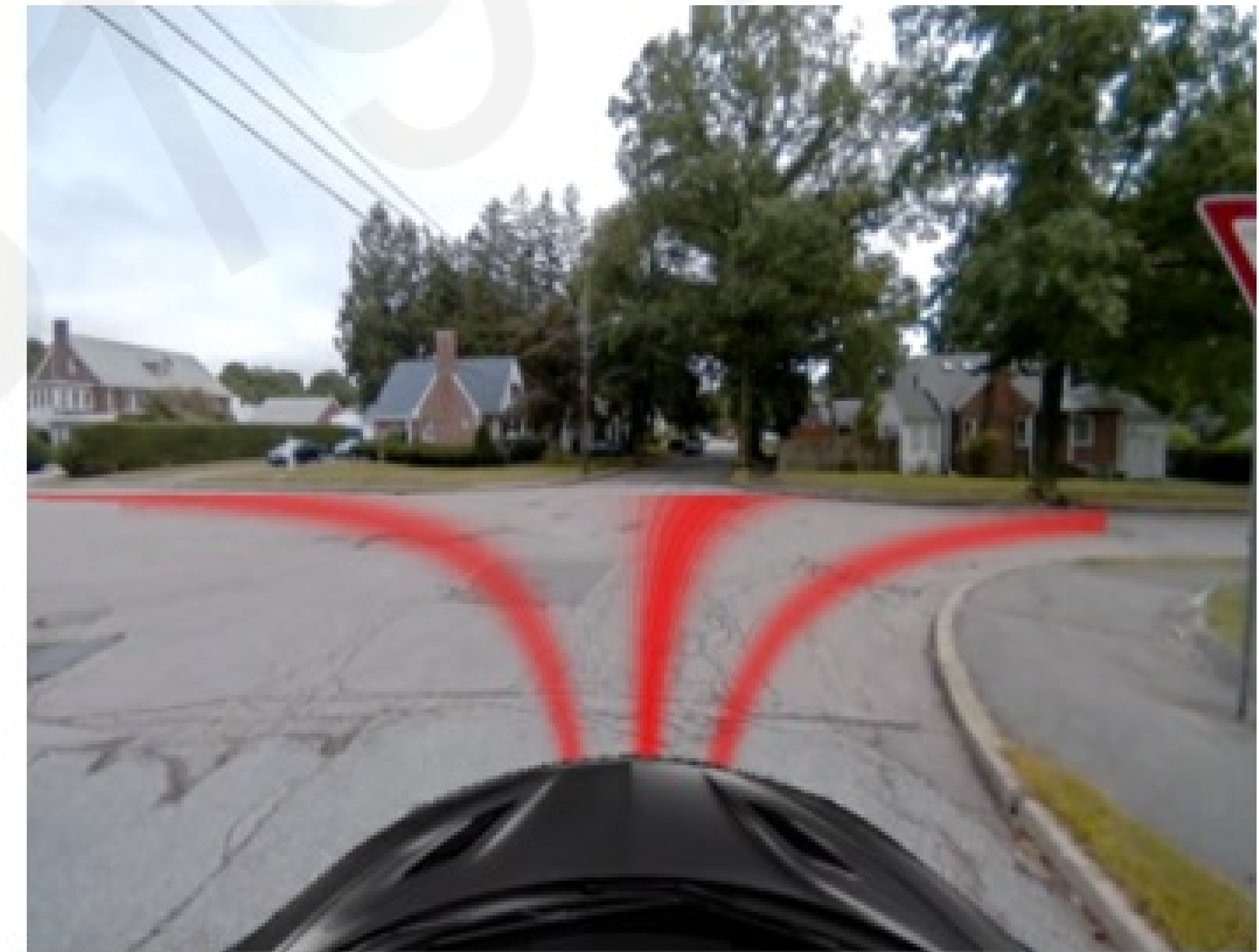

End-to-End Framework for Autonomous Navigation

Entire model is trained end-to-end **without any human labelling or annotations**

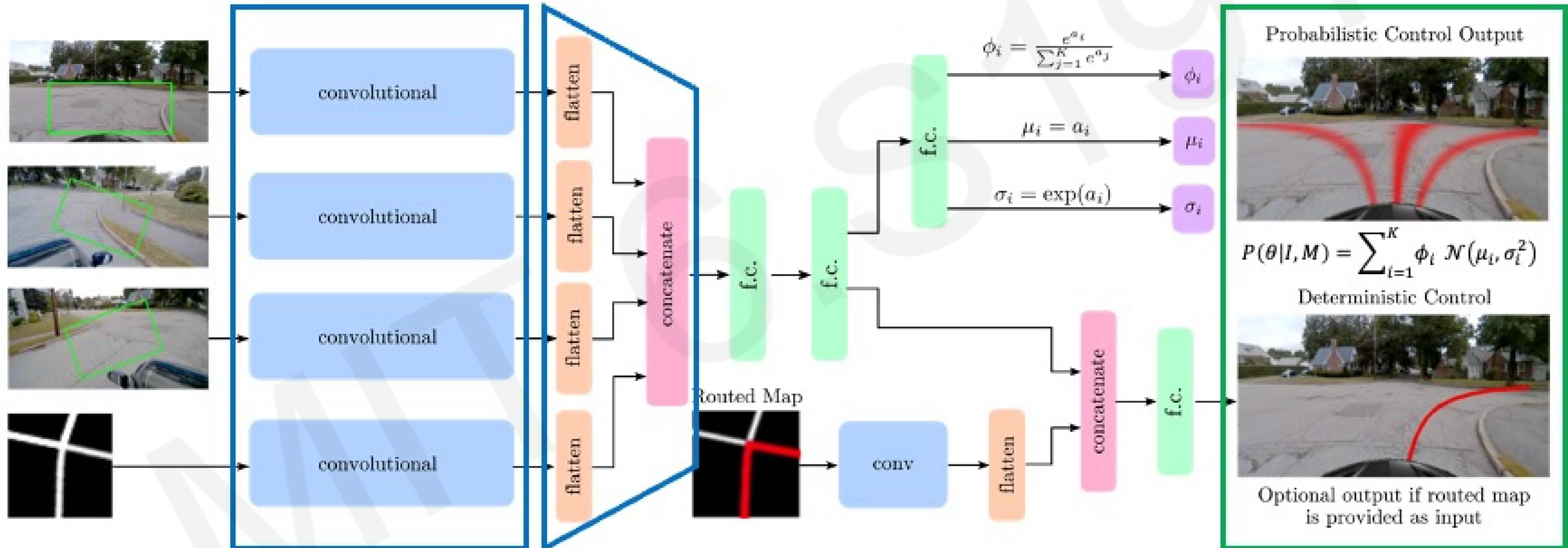

$$L = -\log(P(\theta|I, M))$$



Auto ON

Navigation and Localization



Deep Learning for Computer Vision: Impact



Deep Learning for Computer Vision: Summary

Foundations

- Why computer vision?
- Representing images
- Convolutions for feature extraction



CNNs

- CNN architecture
- Application to classification
- ImageNet

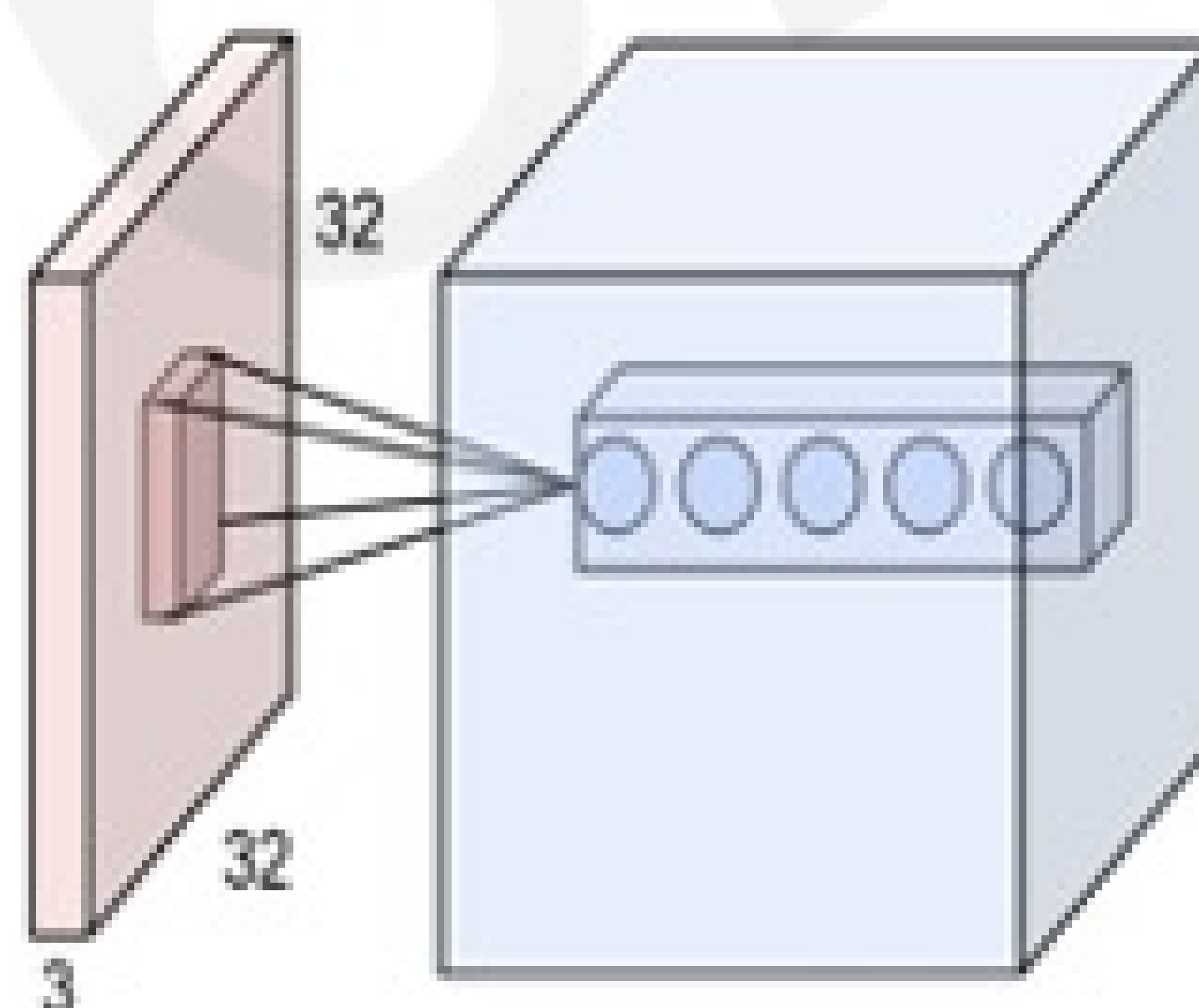

Applications

- Segmentation, image captioning, control
- Security, medicine, robotics





MIT

Introduction to Deep Learning

Lab 2: Facial Detection Systems

Link to download labs:

<http://introtodeeplearning.com#schedule>

1. Open the lab in Google Colab
2. Start executing code blocks and filling in the #TODOs
3. Need help? Come to 32-123!